



The Collection



PERFORMANCE



design



style





Nexus Steam Black and SXS Black



Esprit Stainless Steel

Why choose FALCON?

With a Falcon at the heart of the kitchen, the kitchen is always the heart of the home. That's why you'll find a Falcon in more homes across Europe than any other range cooker. So, why buy a Falcon? If being Britain's No.1 range cooker manufacturer isn't reason enough, read on to find out why we're in more homes than any other.



01

Style and choice.

We offer the biggest range of style, size and fuel types, making it easy for you to find the perfect Falcon match for your kitchen.

02

A family of over 1 million owners.

When you buy a Falcon, you're joining a family. If you're new to range cooking, you'll never think of buying anything else again. If you're already a Falcon owner looking to upgrade, you won't be disappointed. Today, much has changed at Falcon but our principle of creating beautiful, functional, market leading appliances - built by hand in Royal Leamington Spa (U.K.) - continues to underline our success.



03

The right ingredients.

It can take weeks to carefully craft a Falcon. The highest gauge steel is pressed, cut, washed, polished, and finally enamelled with Endurance finish. The frame is triple folded, creating a unique encasement for some of the highest quality components on the market.



04

Quality and testing.

Falcon is Europe's No.1 range cooker brand, and is highly rated by consumers as well as international committees such as the Plus X Award, who distinguish selected products with prizes for innovation, quality and functionality.



CONTENTS

Why choose Falcon	5	Choosing your cooker - Semi-Professional range	
Style guide	6 - 23	Mercury	52
Cooking performance	24 - 26	Deluxe	53
Making your choice		Continental	54
Choosing your oven configuration	28	900S	55
Choosing your hob	29 - 30	Co-ordinating collection	
Why choose Falcon induction	31	Hood collection	57 - 59
Choosing your colour	32	Splashback collection	60
Choosing your cooker - Traditional / Contemporary range		Freestanding refrigeration	
Nexus Steam	34 - 37	Features and functions	62
Nexus SE	38	French-style DXD	63
Nexus	39	American-style SXS	64
Elise	40	American-style SXS Deluxe	65
Elan Deluxe	41	General information	67
Professional+ FX / FXP	42		
Leckford Deluxe	43		
Professional Deluxe	44		
Professional+	45		
Classic Deluxe	46		
Classic	47		
Esprit	48		
Infusion	49		
Kitchener	50		

05

When it comes to cooking, experience matters.

For more than 185 years, the Leamington Spa (U.K.) plant has been striving for excellence. Generations of local families have played their part in making Falcon the success it is today. Our people are passionate and proud of making the best range cookers on the market.

We can rightly say that our products are based on experience.

YOUR DESIGN...



Professional+ 90 Stainless Steel

YOUR STATEMENT...

A RANGE COOKER for every style

Buying a new cooker is a big decision, so to help you decide which Falcon model is for you, we've created a Style Guide on the most popular kitchen looks. The style guide is theme-based and takes into account the most popular trends. It offers something for everyone, from a more traditional feel such as Cottage Chic, Trendy Shaker and Parisian Bistro to the contemporary look of Simply Modern, Urban Industrial and Scandinavian Living.

We've also covered kitchens with colour in our Eastern Inspired and Coastal Retreat schemes.

With plenty of inspiration to get you started, our mood boards will help you pinpoint the look that suits you and your home. We've also suggested some Falcon models to consider – each carefully chosen for its looks, functions, features and finish.



Image courtesy of Lykkedal kitchen, Kristianstad, Sweden - Elise 100 White



COMPACT kitchen?

Don't be fooled into thinking that range cookers are only suited to homes blessed with big kitchens. In reality, there's no reason why those with compact kitchens shouldn't benefit from a feature-packed range cooker.

In fact, designers recommend creating a focal point in a small space and what better solution than an eye-catching range cooker positioned centre-stage? If space is restricted, opt for a 90cm-wide model, which offers all the features of the larger sizes in a smaller package.

urban INDUSTRIAL

CHOOSING YOUR COOKER

We recommend the following cookers to sit perfectly in the Urban Industrial style. Alternatively, you can choose from the full Falcon collection, see pages 34 - 55.

To complete your style, add one of our Falcon hoods and splashbacks (pages 57 - 60).



INFUSION

Available in: 90cm / 110cm
Fuel types: Dual Fuel / Induction

Colours:

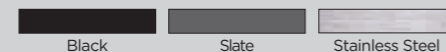

Trim: Chrome

For full details, refer to page 49



NEXUS

Available in: 90cm / 110cm
Fuel types: Dual Fuel / Induction

Colours:



Trim: Satin Chrome

For full details, refer to page 39



900S

Available in: 90cm
Fuel types: Dual Fuel / Induction

Colours:

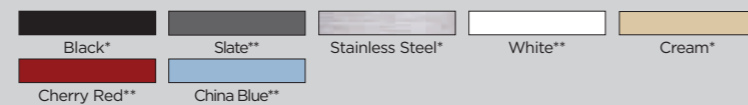

Trim: * Chrome
** Brushed Chrome

For full details, refer to page 55

Perfect for open-plan spaces and loft living, the Urban Industrial look is all about raw, natural materials and a stripped-back utilitarian feel with exposed brick work, reclaimed timber shelving, poured concrete worktops and flooring and old-school pendant lamps.

Think chunky taps, rectangular wall tiles and plenty of metallic accents with steel and copper added to the mix.



Mixed metal, grey and warm reds contribute to creating an Urban Industrial look in your kitchen.



Nexus 110 White

COASTAL retreat

CHOOSING YOUR COOKER

We recommend the following cookers to sit perfectly in the Coastal Retreat style. Alternatively, you can choose from the full Falcon collection, see pages 34 - 55.

To complete your style, add one of our Falcon hoods and splashbacks (pages 57 - 60).



CLASSIC

Available in: 90cm / 100cm / 110cm
Fuel types: Dual Fuel / Induction / Ceramic

Colours:



Trim: Chrome
* 110 Dual Fuel

For full details, refer to page 47



LECKFORD DELUXE

Available in: 90cm / 110cm
Fuel types: Dual Fuel / Induction

Colours:



Trim: Chrome

For full details, refer to page 43



ELISE

Available in: 90cm / 100cm / 110cm
Fuel types: Dual Fuel / Induction

Colours:

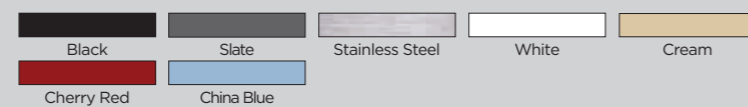

Trim: Brushed Nickel

For full details, refer to page 40

This nautical trend is a fresh, contemporary take on the New England style, with hues of blue and crisp whites taking centre stage. Painted wooden cabinetry makes a statement while marble surfaces, brushed steel brassware and glossy brick tiles add a sophisticated finish.

Accessorise with fisherman's pendant lamps, striped fabrics and sanded wooden flooring to complete the picture.



Use blue, white and cream for a Coastal Retreat feel.



Image courtesy of Loaf - www.loaf.com - Elise 110 China Blue

Parisian BISTRO

CHOOSING YOUR COOKER

We recommend the following cookers to sit perfectly in the Parisian Bistro style. Alternatively, you can choose from the full Falcon collection, see pages 34 - 55.

To complete your style, add one of our Falcon hoods and splashbacks (pages 57 - 60).

The Parisian Bistro style is an invitation to conviviality and warmth in a busy kitchen. Raw materials like bricks, wood and metals are a must to achieve an authentic feel. The Parisian Bistro theme suits both modern and more traditional interiors; it is easily accessorised to give the personality you choose.



Finally, a Falcon range cooker will only add its unique touch thanks to its chunky and trendy look.





Red, white and green are beautiful colours to use in a Parisian Bistro kitchen in combination with raw materials like slate.



CLASSIC DELUXE

Available in: 90cm / 100cm / 110cm
 Fuel types: Dual Fuel / Induction / Ceramic

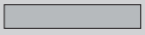
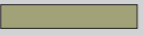
Colours:

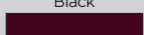
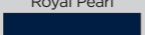
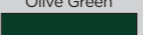
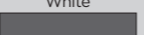
				
Black	Royal Pearl	Olive Green	White	Cream
				
Cranberry	Regal Blue	Racing Green	Slate	

Trim: Chrome or Brass



For full details, refer to page 46



ELISE

Available in: 90cm / 100cm / 110cm
 Fuel types: Dual Fuel / Induction / Ceramic

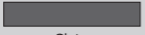
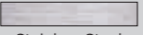
Colours:

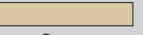
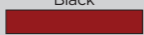
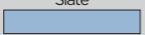
				
Black	Slate	Stainless Steel	White	Cream
				
Cherry Red	China Blue			

Trim: Brushed Nickel

For full details, refer to page 40



CONTINENTAL

Available in: 110cm
 Fuel types: Dual Fuel / Induction

Colours:

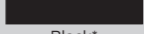
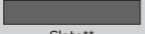
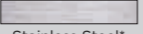
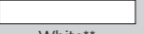
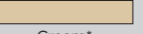
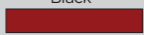
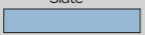
				
Black*	Slate**	Stainless Steel*	White**	Cream*
				
Cherry Red**	China Blue**			

Trim: * Chrome
 ** Brushed Nickel

For full details, refer to page 54



Courtesy of Annette and Christian Photography - Continental 1092 Black

COTTAGE chic

CHOOSING YOUR COOKER

We recommend the following cookers to sit perfectly in the Cottage Chic style. Alternatively, you can choose from the full Falcon collection, see pages 34 - 55.

To complete your style, add one of our Falcon hoods and splashbacks (pages 57 - 60).

Forget twee and traditional, this style blends cottage chic with a classic, timeless feel that suits all interiors. Timber worktops are teamed with wooden cabinetry in a soft, muted palette while appliances are robust and sturdy.

Make an impact with a butler sink and finish your Cottage Chic kitchen with stone flooring and a practical wooden table and chairs.



Neutral colours, including white and cream, mixed with light wood help create a Cottage Chic look.



CLASSIC

Available in: 90cm / 100cm / 110cm
 Fuel types: Dual Fuel / Induction / Ceramic

Colours:

Black
 Cream
 Cranberry

Trim: Chrome

For full details, refer to page 47



CLASSIC DELUXE

Available in: 90cm / 100cm / 110cm
 Fuel types: Dual Fuel / Induction / Ceramic

Colours:

Black
 Royal Pearl
 Olive Green
 White
 Cream
 Cranberry
 Regal Blue
 Racing Green
 Slate

Trim: Chrome or Brass

For full details, refer to page 46



ELAN DELUXE

Available in: 90cm / 110cm
 Fuel types: Dual Fuel / Induction

Colours:

Black
 Royal Pearl
 Olive Green
 Cream
 Cranberry

Trim: Chrome

For full details, refer to page 41



Classic Deluxe 90 Black

simply MODERN

CHOOSING YOUR COOKER

We recommend the following cookers to sit perfectly in the Simply Modern style. Alternatively, you can choose from the full Falcon collection, see pages 34 - 55.

To complete your style, add one of our Falcon hoods and splashbacks (pages 57 - 60).



PROFESSIONAL+ FX / FXP

Available in: 90cm
Fuel types: Dual Fuel / Induction (FX only)

Colours:

Black Cream Cranberry Slate Stainless Steel

Trim: Chrome

For full details, refer to page 42



PROFESSIONAL DELUXE

Available in: 90cm / 100cm / 110cm
Fuel types: Dual Fuel / Induction

Colours:

Black Cream Cranberry Slate Stainless Steel

White

Trim: Chrome

For full details, refer to page 43



NEXUS STEAM

Available in: 110cm
Fuel types: Dual Fuel / Induction

Colours:

Black Slate Stainless Steel Ivory

Trim: Satin Chrome

For full details, refer to page 34 - 37

Less is more for this look, as this modern style focuses on clean lines and a clutter-free finish. Flush-fit hobs and sinks and a professional-style range cooker complement handleless slab doors while a palette of whites, greys, metallics and timber will enhance the sleek, contemporary effect.

Storage is also key - with clever corner units, larders and pull-outs maintaining the minimal feel.

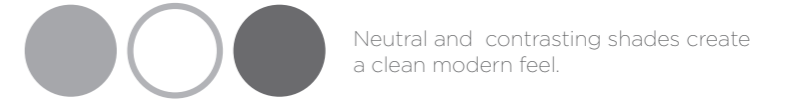

Professional Deluxe 100 White

EASTERN inspired

CHOOSING YOUR COOKER

We recommend the following cookers to sit perfectly in the Eastern Inspired style. Alternatively, you can choose from the full Falcon collection, see pages 34 - 55.

To complete your style, add one of our Falcon hoods and splashbacks (pages 57 - 60).



ESPRIT

Available in: 110cm
Fuel types: Dual Fuel / Induction

Colours:



Trim: Chrome

For full details, refer to page 48



ELISE

Available in: 90cm / 100cm / 110cm
Fuel types: Dual Fuel / Induction

Colours:

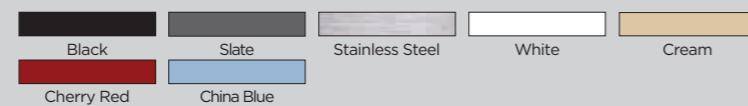

Trim: Brushed Nickel

For full details, refer to page 40



MERCURY

Available in: 100cm / 110cm / 120cm
Fuel types: Dual Fuel / Induction

Colours:

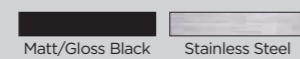

Trim: Polished Stainless Steel

For full details, refer to page 52

A Eastern Inspired theme is a great way of introducing colour and pattern to your kitchen. Use wall and floor tiles in bold intricate prints, add a feature area to an open-plan kitchen-diner with fabulous wallpaper and showcase an exotic selection of herbs and spices.

Finish with Moorish inspired crockery, lanterns, cushions and plenty of leafy houseplants.



Use blue and white as the main colours and add metal touches, like silver or gold, to get that Oriental Inspired feel.



Image courtesy of www.plainenglishdesign.co.uk - Mercury 1200 Black

SCANDINAVIAN living

CHOOSING YOUR COOKER

We recommend the following cookers to sit perfectly in the Scandinavian Living style. Alternatively, you can choose from the full Falcon collection, see pages 34 - 55.

To complete your style, add one of our Falcon hoods and splashbacks (pages 57 - 60).

The Scandinavian Living or Nordic style keeps the kitchen light, bright and airy with slick whites and graphite greys for a clean, contemporary look. Create contrast and interest by adding pops of colour with conical pendants, cookware and patterned textiles.

Patchwork prints, hexagonal mosaics and a feature area finished with a geometric wallpaper design will add a unique twist.



White is at the heart of the Scandinavian Living style. Add colourful accessories to add fun and a trendy style to your kitchen and to match your personality.



PROFESSIONAL DELUXE

Available in: 90cm / 100cm / 110cm
 Fuel types: Dual Fuel / Induction

Colours:

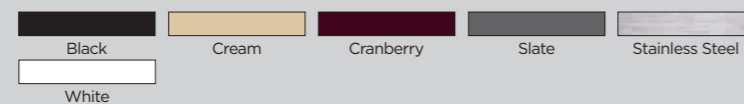

Trim: Chrome

For full details, refer to page 44



NEXUS SE

Available in: 110cm
 Fuel types: Dual Fuel / Induction

Colours:



Trim: Satin Chrome

For full details, refer to page 38



DELUXE

Available in: 90cm / 100cm / 110cm
 Fuel types: Dual Fuel / Induction

Colours:

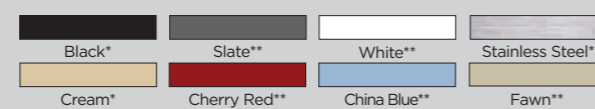

Trim: * Chrome
 ** Brushed Nickel

For full details, refer to page 53



Image courtesy of Åraslöv Kök and Inredningar, Sweden - Deluxe 1092 Black

trendy SHAKER

CHOOSING YOUR COOKER

We recommend the following cookers to sit perfectly in the Trendy Shaker style. Alternatively, you can choose from the full Falcon collection, see pages 34 - 55.

To complete your style, add one of our Falcon hoods and splashbacks (pages 57 - 60).

Key to the Shaker kitchen style is framed and inset panelled furniture with classic proportions. Functional and practical, this traditional look can be given a modern update with an on-trend charcoal or grey painted finish, nickel handles and a steel or colourful cooker taking centre stage. Perfect for homes of all styles and sizes.



Green, light grey and slate blue are perfect shades in a shaker kitchen.



PROFESSIONAL⁺

Available in: 90cm / 100cm / 110cm
Fuel types: Dual Fuel / Induction

Colours:



Trim: Chrome

For full details, refer to page 45



ELAN DELUXE

Available in: 90cm / 110cm
Fuel types: Dual Fuel / Induction

Colours:



Trim: Chrome

For full details, refer to page 41



CONTINENTAL

Available in: 110cm
Fuel types: Dual Fuel / Induction

Colours:

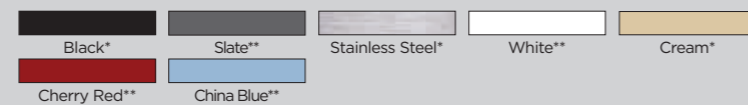

Trim: * Chrome
** Brushed Nickel

For full details, refer to page 54



Professional+ 90 Stainless Steel

COOKING PERFORMANCE

Alexandra, our Home Economist, plays a vital role at Falcon. She ensures that our products are designed to meet the cooking expectations of Falcon customers. So whether you cook daily for a large family, are a keen home baker, have a passion for Asian cooking or are simply a food fanatic you will not be disappointed with your Falcon cooker.

Our products are built to stand the test of time, with everyday use in mind, Falcon range cookers are made from the highest quality materials to ensure longevity and durability.

Whatever style of cooking you prefer, Falcon cookers offer a unique choice of features to make your life easier, creating perfect results every time.



Falcon Specialist Features



GRIDDLE

Made from robust cast aluminium, the griddle plate sits snugly on top of the gas hob, when required. The flat plate is ideal for cooking bacon and French toast, while the grooved plate provides fat drainage, offering a healthier way to sear steaks, burgers and fish.



TEPPANYAKI GRIDDLE

Cook healthy food Japanese-style with the unique Teppanyaki-style griddle plate that fits snugly over the burners. It is coated for non-stick easy cleaning.



BRIDGING-ZONE

Our next generation induction hobs feature a bridging-zone that can be used as two separate cooking zones, one large cooking zone or as a base for our innovative induction griddle.



MULTI-RING BURNER

Create authentic Asian cuisine on our powerful multi-ring burner, with a our specially designed wok cradle.



MULTI-ZONE

Choose between two ceramic 1.1kW cooking zones, or slot a durable non-stick, flat griddle plate over the top to provide a healthy cooking surface.



PROVING DRAWER

Our proving drawer is a unique feature in the world of range cooking; it helps you to effortlessly rest and rise your dough before baking. And it doubles as a handy storage drawer.



GLIDE-OUT GRILL

Positioned on smooth-action telescopic runners, our glide-out grill does exactly that. Not only is it easier to check up on your food as it is grilling, but it is also safer; it reduces the risk of pulling the grill out too far. The glide-out grill includes a grillpan with a height-adjustable trivet.



INJECTION STEAM CAVITY

A dedicated, atmospheric steam cavity with steam, grill and descale functions and pre-programmed settings for the preparation of vegetables, fish and meat. The cavity is also suitable for sous-vide cooking.



LARGE OVEN CAPACITY

With an average main oven capacity of 73L (83L conventional) and up to 114 litres, the Falcon oven leads the way for size and performance. A-rated across the board and ultrafast pre-heating with Rapid Response make Falcon ovens the largest and most efficient available.



NON SCRATCH ENAMEL

Our Endurance™ finish is eco-friendly, durable and will last for years to come. On our range cookers we only use environmentally friendly, top-quality paints and enamels supplied by the global leader in the field, and applied at our factory in the United Kingdom.

Falcon multifunction oven

Falcon multifunction ovens offer up to eleven functions for really flexible cooking. The ovens combine fan and conventional functions with grilling, base heat and browning elements, all of which can be used individually. Use the base heat to crisp the base of your pizza; fan grill whole fish; brown a pasta bake; cook your roasts using the fan assisted function or bake using the conventional function.



FAN ASSISTED OVEN

Uses the top and bottom oven elements alongside the fan. It creates different temperature zones - with the hottest being at the top; ideal for crisping and browning the top and bottom of dishes as well as cooking them through



FANNED GRILLING

Uses the top oven element in conjunction with the fan. Fan grilling provides a grilled effect without the need to turn the food. Grill with the door closed.



CONVENTIONAL OVEN

Traditional cooking method using top and bottom heat and zoned cooking. Much hotter at the top than the bottom. Ideal for traditional baking, e.g soufflé.



FAN OVEN

Uses an element at the back of the oven. The fan draws air from the interior of the oven, heats it up and forces it back into the cavity. The heat within the oven is evenly distributed making it ideal for multi-level cooking (batch cooking or the cooking of different foods at the same temperature)



BROWNING ELEMENT

Uses the exposed top element only to create a very high intense heat for browning and toasting.



DEFROST

Uses the fan only - no heat. Cold air is drawn from the frozen food to speed up the defrosting process.



BASE HEAT

Uses only the bottom element. Base heat can be used for slow, gentle cooking or, when turned up to high, for crisping up the base of dishes.



DUO

Setting to produce perfectly baked pastry without the need for blind baking.



DELICATE

Function to prepare delicate dishes such as meringues or soufflé.



ECO

Energy saving, time-based function for foods requiring 45 minutes cooking or less. Especially suitable for ready prepared meals and non-yeast baked food like cookies and brownies.



RAPID RESPONSE

Preheats fan ovens up to 30% faster than when using the fan alone. Allows cooking to start immediately.



MAKING YOUR CHOICE...



Choosing your OVEN CONFIGURATION...

90CM

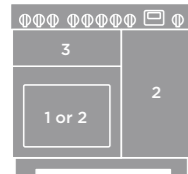

MULTIFUNCTION/FAN OVEN

- Classic Deluxe
- Nexus
- Professional Deluxe

2 FAN OVENS

- Classic
- Infusion
- Kitchener
- Professional+

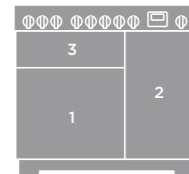

MULTIFUNCTION/FAN OVEN

- Deluxe
- Elan Deluxe
- Elise
- Leckford Deluxe

SINGLE CAVITY with Energy Saving Panel (divider)

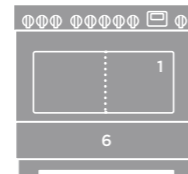

MULTIFUNCTION OVEN (single and with divider)

- Professional+ FX/FXP

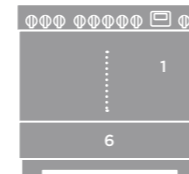

MULTIFUNCTION OVEN (single and with divider)

- 900S

100CM

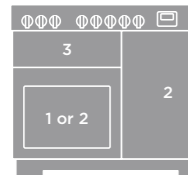

MULTIFUNCTION/FAN OVEN

- Classic Deluxe
- Professional Deluxe

2 FAN OVENS

- Classic
- Kitchener
- Professional+

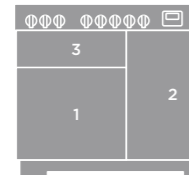

MULTIFUNCTION/FAN OVEN

- Deluxe
- Elise
- Mercury

120CM

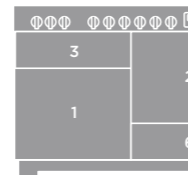

MULTIFUNCTION/FAN OVEN

- Mercury 1200

110CM

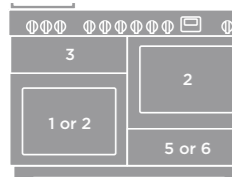

MULTIFUNCTION/FAN OVEN

- Classic Deluxe
- Nexus
- Professional Deluxe

2 FAN OVENS

- Classic
- Infusion
- Kitchener
- Professional+

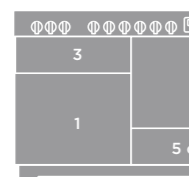

MULTIFUNCTION/FAN OVEN

- Deluxe
- Elan Deluxe
- Elise
- Leckford Deluxe
- Mercury

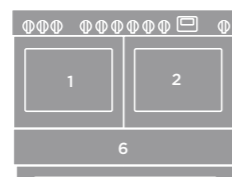

MULTIFUNCTION/FAN OVEN

- Continental

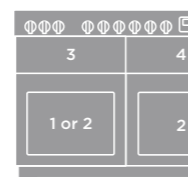

MULTIFUNCTION/FAN OVEN

- Nexus SE
- ### 2 FAN OVENS
- Esprit

KEY

1. Multifunction oven
2. Fan oven
3. Glide-out grill
4. Slow cook oven
5. Proving/Storage drawer
6. Storage drawer



Choosing your COOKING HOB...

All our ovens are electric. However, you can choose the hob that best suits your preferred way of cooking.

GAS (Dual Fuel)

The most popular hob fuel choice is gas. Gas offers instant heat that is completely controllable and evenly distributed. All Falcon gas hobs can be converted to accept liquid petroleum gas (LPG) using a conversion kit.

TRADITIONAL AND CONTEMPORARY RANGE COOKERS

MODELS

- Classic 90 / 100
- Classic Deluxe 90 / 100
- Elan Deluxe 90
- Infusion 90
- Kitchener 90 / 100
- Leckford Deluxe 90
- Nexus 90
- Professional+ 90 / 100
- Professional+ FX/FXP

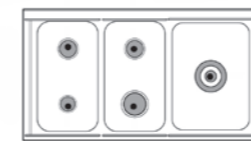

MODELS

- Elise 90

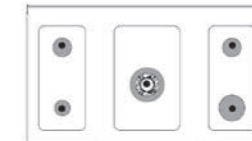

MODELS

- Elise 110

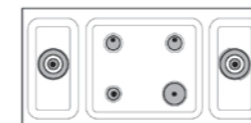

MODELS

- Classic 110
- Infusion 110
- Kitchener 110
- Professional Deluxe 110
- Professional+ 110

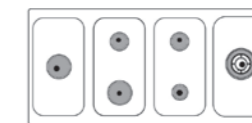

MODELS

- Classic Deluxe 110
- Elan Deluxe 110
- Leckford Deluxe 110
- Nexus 110
- Nexus SE
- Nexus Steam

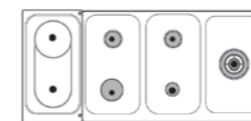

SEMI-PROFESSIONAL RANGE COOKERS

MODELS

- 900S
- Continental
- Deluxe 900 / 1000 / 1092
- Mercury 1000 / 1082 / 1200

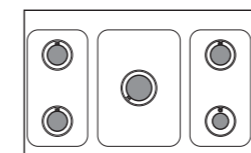

INDUCTION

Fast, responsive and incredibly controllable, an induction hob offers the ultimate in speed and energy efficiency. No wonder it's the fastest growing hob choice today. Boasting a wealth of safety features, all Falcon induction hobs harness i5TM induction technology for the most eco-friendly hob-top cooking possible.

TRADITIONAL AND CONTEMPORARY RANGE COOKERS

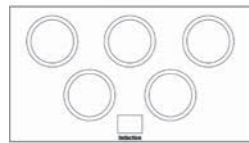

MODELS

- Classic Deluxe 90 / 100 / 110
- Classic 90 / 100 / 110
- Professional+ FX
- Professional+ 90 /110
- Professional Deluxe 90 / 110
- Infusion 90 / 110



MODELS

- Elan Deluxe 90 / 110
- Elise 90 / 100 / 110
- Leckford Deluxe 90 / 110
- Nexus 90 / 110
- Nexus SE

COOKING ZONE DIMENSIONS

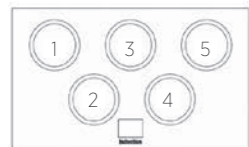

Zones 1, 4, 5: Inner 140mm
 Zone 2: Inner 120mm
 Zone 3: Inner 160mm

COOKING ZONE DIMENSIONS



Zones 1, 2, 4: Inner 180mm
 Zone 3: Inner 210mm
 Zone 5: Inner 145mm

SEMI-PROFESSIONAL RANGE COOKERS

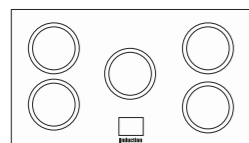

MODELS

- 900S
- Continental
- Deluxe 900 / 1000 / 1092
- Mercury 1000 / 1082 / 1200

COOKING ZONE DIMENSIONS

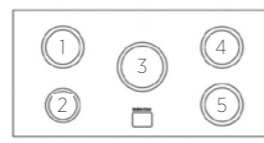

Zones 1, 4, 5: Inner 140mm
 Zone 2: Inner 120mm
 Zone 3: Inner 160mm

CERAMIC

Falcon ceramic hobs boast impressive heat-up times and are very responsive. They are the perfect alternative for people who have a limited budget but who prefer the streamlined glass look and the ease of cleaning of an induction hob.

TRADITIONAL AND CONTEMPORARY RANGE COOKERS



MODELS

- Classic 90
- Classic Deluxe 110



MODELS

- Classic 110
- Classic Deluxe 110

COOKING ZONE DIMENSIONS

90cm	Ceramic field	Zone 1 (mm)	Zone 2 (mm)	Zone 3 (mm)	Zone 4 (mm)	Zone 5 (mm)
Classic		200	165	165	200/125	230/144
Classic Deluxe		200	165	165	200/125	230/144

110cm	Ceramic field	Zone 1 (mm)	Zone 2 (mm)	Zone 3 (mm)	Zone 4 (mm)	Zone 5 (mm)	Zone 6 (mm)
Classic Deluxe		230/144	200	165	165	200/125	165
Classic		230/144	200	165	165	200/125	165



Why choose
FALCON INDUCTION?

The Falcon induction models are equipped with our premium induction technology - smart, intelligent and ultra-efficient.

A **AUTOMATIC HEAT UP SETTING**
 Applies maximum power to the selected zone for a brief period. Ideal for cooking rice and pasta.

1-9 **ZONE POWER SETTINGS 1 - 9**
 Nine Power settings giving instant response and full controllability through rotary controls.

L1 **PREPARATION SETTING**
 Pre-set temperature setting of 44°C. Ideal for gently melting butter or chocolate.

P **POWER BOOST SETTING**
 Makes additional power available therefore quicker cooking times giving greater flexibility and control.

L2 **KEEP WARM SETTING**
 Pre-set temperature setting of 70°C. Perfect for keeping food warm, once cooked.

H **RESIDUAL HEAT INDICATOR**
 A safety feature. The residual heat indicator symbol will appear in the display to show that a zone is still hot; it shows that the cooking zone temperature is above 60°C and may still cause burns.

L3 **OPTIMUM SIMMER**
 Pre-set temperature of 94°C, the perfect temperature for simmering soups and stews, or preparing sauces.

0 **CHILD LOCK**
 Locks the zones when not switched on to prevents the unwanted use by children.

Available low temperature settings depending on product and model choice.

People with cardiac pacemakers or implanted insulin pumps must make sure that their implants are not affected by the induction hob. (The frequency range of the induction hob is 20-60kHz).



While Stainless Steel looks fantastic in many kitchens, it needn't be the only choice. Bring your kitchen alive by choosing a range cooker from an array of stunning colours.

- | | | | |
|----|-----------------|----|--|
| 01 | Stainless Steel | 02 | Cream |
| 03 | Cherry Red | 04 | Black / Matt Black*
<small>*Mercury</small> |
| 05 | Regal Blue | 06 | White |
| 07 | Ivory | 08 | Cranberry |
| 09 | Slate | 10 | Racing Green |
| 11 | Royal Pearl | 12 | Olive Green |
| 13 | China Blue | 14 | Fawn |

Trim options:

- Chrome
- Brass
- Satin Chrome
- Brushed Nickel
- Polished Stainless Steel
- Nickel

Colour and trim options depending on product choice.



TRADITIONAL AND CONTEMPORARY RANGE

Whether you want a traditional style or the clean, sophisticated lines of something a little more contemporary, a Falcon range cooker will become the cornerstone of your kitchen. Distinctive, efficient, highly versatile and made to our exacting standards, every Falcon is designed to make cooking a pleasure, not a chore.

NEXUS Steam

The *ultimate* cooking experience...

Removable dishwasher safe pan supports, griddle, grill tray, grill trivet, steam trays and oven shelves for easy cleaning and maintenance.

Unique sleek black glass fascia panel with premium, ergonomic rotary control dials for ultimate durability.



Five gas burners including a 3.5kW multi-ring burner and wok cradle for powerful high-heat cooking.

Multi-zone griddle for healthy cooking.



Electronic LED touch control interface for cooking at the touch of a button.



Superior precise electronic temperature range starting at 40 °C up to 260 °C. Perfect for long slow cooking e.g. cooking meat for 12 hours at 85 °C.

35 Litre steam injection cavity

- Versatile cooking
- Superior nutrient retention
- Precise temperature control
- Innovation at your fingertips
- Effortless, safe cooking



Multifunction oven with 11 functions including new Duo setting for perfectly baked pastry dishes without the need to bake blind and new Delicate Bake setting for delicate dishes such as cheesecake or soufflé.



Easily check on food with two telescopic shelves.

Falcon branded plinth.

Dedicated bread proving drawer for perfectly proven dough.



NEXUS STEAM



110cm



Trim: Satin Chrome

KEY FEATURES

- Programmable multifunction oven with 11 settings, including Duo, Delicate, ECO and Rapid Response
- Programmable injection steam cavity with integrated grill
- Shelves:
 - Multifunction oven: 2 x telescopic
 - Steam cavity: 1 x wire rack; 1 x standard tray, 1 x deep perforated tray
- Precise electronic temperature control to within 1°C
- Separate deluxe glide-out grill (dual-circuit) with height-adjustable trivet (4 heights)
- Gas hob options:
 - 5 burners, including a multi-ring burner, a wok cradle and a ceramic multi-zone with 2 cooking zones and a flat griddle
- Induction hob options:
 - 5 cooking zones, two of which can be linked to create one large cooking zone or a zone for a griddle (included), and 3 pre-set low-heat settings (approx. L1 40°C, L2 70°C, L3 90°C)
- Proving / Storage drawer
- Glass fascia

HOB OPTIONS

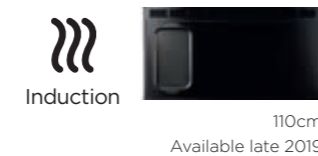

Oven dimensions are for information only; they should not be used to define oven cookware dimensions.

SPECIFICATIONS

Model	NEXUS STEAM 110	
Hob fuel type	Dual Fuel	Induction
Product code	NEX110SODF	NEX110SOEI
Width (mm)	1092	1100
Height to hotplate (mm) min / max	905 / 930	905 / 930
Depth excluding/including handles (mm)	604 / 648	608 / 685
Weight (kg)	143	143
Electrical ratings specified at 230VAC	3.00 1.70 1.70 1.00 3.50	1.85 / 2.50 1.85 / 2.50 1.85 / 3.20 1.85 / 2.50 1.15 / 2.00
Multi-zone / Bridging-zone / Dual-purpose zone	Multi-zone (2 x 1.10kW)	Bridging-zone
Total hob rating (kW)	Gas: 10.90 Electrical: 2.20	7.40
Single-phase connection (A)	30.29	66.00
Three-phase connection (A)	3 x 16	3 x 25
Maximum electrical load (kW @ 230V)	6.95	15.30
Grill power rating (kW)	2.30	2.30
Separate grill	Glide-out	Glide-out
Oven temperature °C max	MF: 260; SC: 100; Grill: 200	MF: 260; SC: 100; Grill: 200
Slow cook oven °C max	-	-
Dimensions - Multifunction oven (W x H x D)	467 x 438 x 385	467 x 438 x 385
Capacity - Multifunction oven (litres)	79	79
Energy rating - Multifunction oven	A	A
Dimensions - Steam cavity (W x H x D)	420 x 215 x 387	420 x 215 x 387
Capacity - Steam cavity (litres)	35	35
Energy rating - Steam cavity	-	-
Oven shelves (+1 = Plate rack)	MF: 2; SC: 3 (Wire rack/ Perforated tray/Flat tray)	MF: 2; SC: 3 (Wire rack/ Perforated tray/Flat tray)
Pan support material	Cast iron / Removable	-
Timer type	LED / White display	LED / White display
Oven light	Both ovens	Both ovens
Oven liners: Catalytic (C) / Enamel (E)	MF: C - SC: SS	MF: C - SC: S/S

GAS HOB / MULTI-ZONE

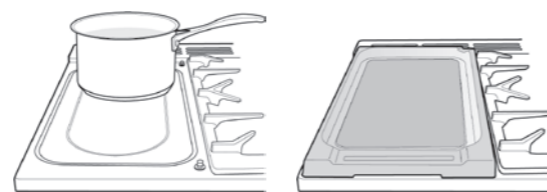

INDUCTION HOB / BRIDGING-ZONE

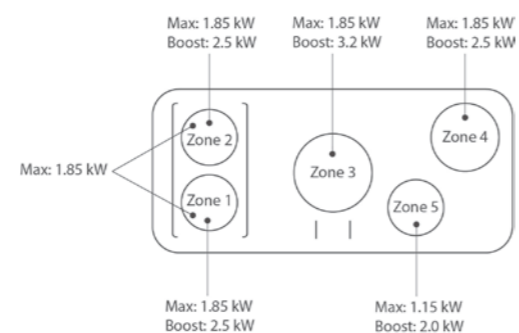

- **Unique** range cooker with a **dedicated steam cavity**

- Electronic thermostat - **single degree accuracy** in the multifunction oven and steam cavity

- Electronic controls offering **ultimate precision** and control

- Premium **seamless sealed glass fascia** with ergonomic rotary controls and markings sealed behind the glass panel

The possibilities are endless:

simultaneously: bake, batch cook, boil, brown, dry, grill, griddle, preserve, prove, roast, simmer, slow cook, sous vide, steam, sterilise, stir fry

Induction data subject to change.

NEXUS SE



110cm



Trim: Satin Chrome

KEY FEATURES

- Three electric ovens:
 - Main, programmable multifunction oven (8 functions)
 - Fan oven
 - Slow cook oven
- Handyrack
- Rapid Response
- Separate deluxe glide-out grill (dual-circuit) with height-adjustable trivet (4 heights)
- Gas hob options:
 - 5 burners, including a multi-ring burner, a wok cradle and a ceramic multi-zone with 2 cooking zones and a flat griddle
- Induction hob options:
 - 5 cooking zones, two of which can be linked to create one large cooking zone or a zone for a griddle (included), and 3 pre-set low-heat settings (approx. L1 40°C, L2 70°C, L3 90°C)

HOB OPTIONS



110cm



110cm

NEXUS



110cm



Trim: Satin Chrome

KEY FEATURES

- Three electric ovens:
 - Programmable multifunction oven (7 functions)
 - Fan oven
 - Slow cook oven
- Rapid Response
- Separate deluxe glide-out grill (dual-circuit) with height-adjustable trivet (4 heights)
- Handyrack
- Gas hob options:
 - 90 Model: 5 burners, including a multi-ring burner, a wok cradle and half smooth-half grooved griddle
 - 110 Models: 5 burners, including a multi-ring burner, a wok cradle and a ceramic multi-zone with 2 cooking zones and a flat griddle
- Induction hob options:
 - 5 cooking zones, two of which can be linked to create one large cooking zone or a zone for a griddle (included), and 3 pre-set low-heat settings (approx. L1 40°C, L2 70°C, L3 90°C)
- Proving / Storage drawer (110 models)

HOB OPTIONS



90cm



110cm



90cm

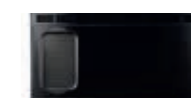

110cm

Oven dimensions are for information only; they should not be used to define oven cookware dimensions.

SPECIFICATIONS		
Model	NEXUS SE 110	
Hob fuel type	GAS (DF)	INDUCTION
Product code	NEXSE110DF	NEXSE110EI
Width (mm)	1092	1100
Height to hotplate (mm) min / max	905 / 930	905 / 930
Depth excluding/including handles (mm)	604 / 648	608 / 646
Weight (kg)	140	141
Electrical ratings specified at 230VAC	300	185 / 250
	170	185 / 250
	170	185 / 320
	100	185 / 250
	350	115 / 200
	-	-
Multi-zone / Bridging-zone / Dual-purpose zone	Yes	Incl. bridging zone
Total hob rating (kW)	10.90	7.40
Single-phase connection (A)	52.00	74.00
Three-phase connection (A)	3 x 25	3 x 25
Maximum electrical load (kW @ 230V)	11.80	17.00
Grill power rating (kW)	2.30	2.30
Separate grill	Glide-out	Glide-out
Oven temperature °C max	240	240
Slow cook oven °C max	140	Yes - Max. 140
Dimensions - LH oven (W x H x D)	467 x 438 x 385	467 x 438 x 385
Capacity - LH oven (litres)	79	79
Energy rating - LH oven	A	A
Dimensions - RH oven (W x H x D)	467 x 438 x 385	467 x 438 x 385
Capacity - RH oven (litres)	79	79
Energy rating - RH oven	A	A
Oven shelves (+1 = Plate rack)	L: 2 Flat - R: 2 Flat	L: 2 Flat - R: 2 Flat
Pan support material	Cast iron / Removable	-
Timer type	3 Button 24 Hour / White display	3 Button 24 Hour / White display
Oven light	Both ovens	Both ovens
Oven liners: Catalytic (C) / Enamel (E)	Both ovens: C	Both ovens: E



Oven dimensions are for information only; they should not be used to define oven cookware dimensions.

SPECIFICATIONS				
Model	NEXUS 90		NEXUS 110	
Hob fuel type	GAS (DF)	INDUCTION	GAS (DF)	INDUCTION
Product code	NEX90DF	NEX90EI	NEX110DF	NEX110EI
Width (mm)	900	900	1092	1092
Height to hotplate (mm) min / max	905 / 930	905 / 930	905 / 930	905 / 930
Depth excluding/including handles (mm)	608 / 648	608 / 648	608 / 648	608 / 648
Weight (kg)	120	120	143	130
Electrical ratings specified at 230VAC	100	185 / 250	300	115 / 200
	170	185 / 250	170	185 / 250
	170	185 / 320	170	185 / 300
	300	115 / 200	100	185 / 250
	350	185 / 250	350	115 / 200
	-	-	-	-
Multi-zone / Bridging-zone / Dual-purpose zone	-	-	Multi-zone (2 x 1.1kW)	-
Total hob rating (kW)	10.90	7.40	10.90 + Multi-zone 2.20	7.40
Single-phase connection (A)	32.17	64.35	42.83	65.17
Three-phase connection (A)	3 x 16	3 x 25	3 x 25	3 x 25
Maximum electrical load (kW @ 230V)	7.40	14.80	9.85	14.99
Grill power rating (kW)	2.3	2.3	2.3	2.3
Separate grill	Glide-out	Glide-out	Glide-out	Glide-out
Oven temperature °C max	240	240	240	240
Slow cook oven °C max	-	-	-	-
Dimensions - LH oven (W x H x D)	467 x 438 x 385	467 x 438 x 385	467 x 438 x 385	467 x 438 x 385
Capacity - LH oven (litres)	79	79	79	79
Energy rating - LH oven	A	A	A	A
Dimensions - RH oven (W x H x D)	297 x 577 x 389	297 x 577 x 389	467 x 438 x 385	467 x 438 x 385
Capacity - RH oven (litres)	67	67	73	73
Energy rating - RH oven	A	A	A	A
Oven shelves (+1 = Plate rack)	LH: 2 Flat - RH: 4 Flat (+1)	LH: 2 Flat - RH: 4 Flat (+1)	LH: 2 Flat - RH: 2 Flat	LH: 2 Flat - RH: 2 Flat
Pan support material	Cast iron / Removable	-	Cast iron / Removable	-
Timer type	3 Button / White display	3 Button / White display	3 Button / White display	3 Button / White display
Oven light	LH oven	LH oven	Both ovens	Both ovens
Oven liners: Catalytic (C) / Enamel (E)	LH: C - RH: E	LH: C - RH: E	LH: C - RH: C	LH: C - RH: C

ELISE



KEY FEATURES

- Two electric ovens:
 - Multifunction oven (7 functions)
 - Fan oven
- Handyrack
- Separate deluxe glide-out grill (dual-circuit) with height-adjustable trivet (4 heights)
- Handyrack
- Gas hob options:
 - 90 Model: 5 burners, including a multi-ring burner, and a wok cradle
 - 110 Model: 6 burners, including two multi-ring burners, and a wok cradle
- Induction hob options:
 - 5 cooking zones, two of which can be linked to create one large cooking zone or a zone for a griddle (included), and 3 pre-set low-heat settings (approx. L1 40°C, L2 70°C, L3 90°C)
- Premium stainless steel hotplate (dual fuel models)
- Storage drawer (110 models)

HOB OPTIONS

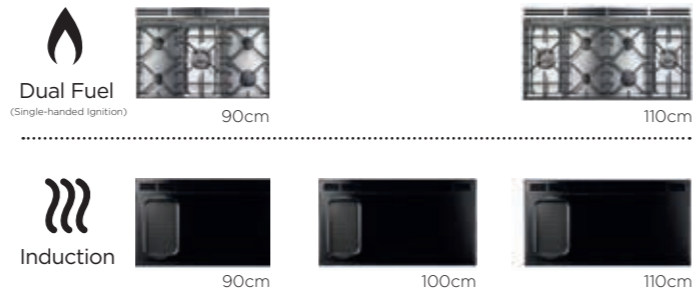

Trim: Brushed Nickel

Oven dimensions are for information only; they should not be used to define oven cookware dimensions.

SPECIFICATIONS

Model	ELISE 90		ELISE 100		ELISE 110	
	GAS (DF)	INDUCTION	INDUCTION	GAS (DF)	INDUCTION	
Hob fuel type	GAS (DF)	INDUCTION	INDUCTION	GAS (DF)	INDUCTION	
Product code	ELS90DF	ELS90EI	ELS100EI	ELS110	ELS110EI	
Width (mm)	900	900	994	1092	1092	
Height to hotplate (mm) min / max	910 / 935	910 / 935	910 / 935	910 / 935	910 / 935	
Depth excluding/including handles (mm)	598 / 650	600 / 650	600 / 650	598 / 650	600 / 650	
Weight (kg)	129	126	134	135	149	
Electrical ratings specified at 230VAC	100	185 / 250	185 / 250	350	185 / 250	
	170	185 / 250	185 / 250	170	185 / 250	
	170	185 / 320	185 / 320	100	185 / 320	
	300	185 / 250	185 / 250	170	185 / 250	
	350	115 / 200	115 / 200	350	115 / 200	
	-	-	-	300	-	
Multi-zone / Bridging-zone / Dual-purpose zone	-	-	Bridging-zone	-	Bridging-zone	
Total hob rating (kW)	10.90	7.40	7.40	14.40	7.40	
Single-phase connection (A)	32.17	64.35	64.35	32.17	64.30	
Three-phase connection (A)	3 x 16	3 x 25	3 x 25	3 x 16	3 x 25	
Maximum electrical load (kW @ 230V)	7.40	14.80	14.80	7.40	14.80	
Grill power rating (kW)	2.30	2.30	2.30	2.30	2.30	
Separate grill	Glide-out	Glide-out	Glide-out	Glide-out	Glide-out	
Oven temperature °C max	240	240	240	240	240	
Slow cook oven °C max	-	-	-	-	-	
Dimensions - LH oven (W x H x D)	467 x 438 x 385	467 x 438 x 385	467 x 438 x 385	467 x 438 x 385	467 x 438 x 385	
Capacity - LH oven (litres)	79	79	79	79	79	
Energy rating - LH oven	A	A	A	A	A	
Dimensions - RH oven (W x H x D)	297 x 577 x 389	297 x 577 x 389	362 x 577 x 389	467 x 438 x 385	467 x 438 x 385	
Capacity - RH oven (litres)	67	67	82	79	79	
Energy rating - RH oven	A	A	A	A	A	
Oven shelves (+1 = Plate rack)	LH: 2 Flat - RH: 4 Flat (+1)	LH: 2 Flat - RH: 4 Flat (+1)	LH: 2 Flat - RH: 4 Flat (+1)	LH: 2 Flat - RH: 2 Flat	LH: 2 Flat - RH: 2 Flat	
Pan support material	Cast iron / Removable	-	-	Cast iron / Removable	-	
Timer type	-	-	-	-	-	
Oven light	LH oven	LH oven	LH oven	Both ovens	Both ovens	
Oven liners: Catalytic (C) / Enamel (E)	LH: C - RH: E	LH: C - RH: E	LH: C - RH: E	LH: C - RH: C	LH: C - RH: C	

ELAN DELUXE



KEY FEATURES

- Two electric ovens:
 - Programmable multifunction oven (8 functions)
 - Fan oven
- Handyrack
- Separate deluxe glide-out grill (dual-circuit) with height-adjustable trivet (4 heights)
- Gas hob options:
 - 90/100 Models: 5 burners, including a multi-ring burner, a half smooth-half grooved griddle and a wok cradle
 - 110 Models: 5 burners, including a multi-ring burner, a wok cradle and a ceramic multi-zone with 2 cooking zones and a flat griddle
- Induction hob options:
 - 5 cooking zones, two of which can be linked to create one large cooking zone or a zone for a griddle (included), and 3 pre-set low-heat settings (approx. L1 40°C, L2 70°C, L3 90°C)
- Proving/Storage drawer (110 models)

HOB OPTIONS

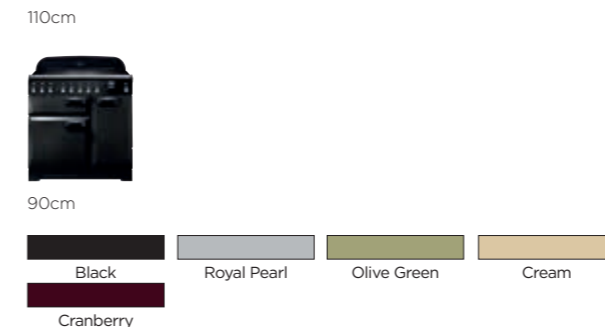
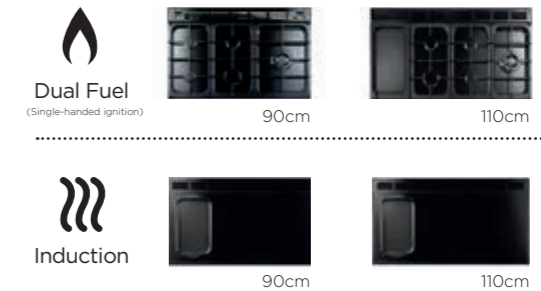

Trim: Chrome

Oven dimensions are for information only; they should not be used to define oven cookware dimensions.

SPECIFICATIONS

Model	ELAN DELUXE 90		ELAN DELUXE 110	
	GAS (DF)	INDUCTION	GAS (DF)	INDUCTION
Hob fuel type	GAS (DF)	INDUCTION	GAS (DF)	INDUCTION
Product code	ELA90DF	ELA90EI	ELA110DF	ELA110EI
Width (mm)	900	900	1092	1100
Height to hotplate (mm) min / max	905 / 930	905 / 930	905 / 930	905 / 930
Depth excluding/including handles (mm)	608 / 685	608 / 685	608 / 685	608 / 685
Weight (kg)	129	128	143	143
Electrical ratings specified at 230VAC	100	185 / 250	300	185 / 250
	170	185 / 250	170	185 / 250
	170	185 / 320	170	185 / 320
	300	115 / 200	100	185 / 250
	350	185 / 250	350	115 / 200
	-	-	-	-
Multi-zone / Bridging-zone / Dual-purpose zone	-	-	Multi-zone (2 x 110kW) Gas: 10.90 Electric 2.20	Bridging-zone
Total hob rating (kW)	10.90	7.40	Gas: 10.90 Electric 2.20	7.40
Single-phase connection (A)	37.39	69.57	47.83	70.43
Three-phase connection (A)	3 x 16	3 x 25	3 x 16	3 x 25
Maximum electrical load (kW @ 230V)	8.60	16.00	11.00	16.20
Grill power rating (kW)	2.30	2.30	2.30	2.30
Separate grill	Glide-out	Glide-out	Glide-out	Glide-out
Oven temperature °C max	240	240	240	240
Slow cook oven °C max	-	-	-	-
Dimensions - LH oven (W x H x D)	467 x 438 x 385	467 x 438 x 385	467 x 438 x 385	467 x 438 x 385
Capacity - LH oven (litres)	79	79	79	79
Energy rating - LH oven	A	A	A	A
Dimensions - RH oven (W x H x D)	297 x 577 x 389	297 x 577 x 389	467 x 438 x 385	467 x 438 x 385
Capacity - RH oven (litres)	67	67	79	79
Energy rating - RH oven	A	A	A	A
Oven shelves (+1 = Plate rack)	LH: 2 Flat - RH: 4 Flat (+1)	LH: 2 Flat - RH: 4 Flat (+1)	LH: 2 Flat - RH: 2 Flat	LH: 2 Flat - RH: 2 Flat
Pan support material	Cast iron / Removable	-	Cast iron / Removable	-
Timer type	3 Button/White display	3 Button/White display	3 Button/White display	3 Button/White display
Oven light	LH oven	LH oven	Both ovens	Both ovens
Oven liners: Catalytic (C) / Enamel (E)	LH: C - RH: E	LH: C - RH: E	Both ovens	Both ovens

PROFESSIONAL+ FX / FXP



90cm



With E.S.P.

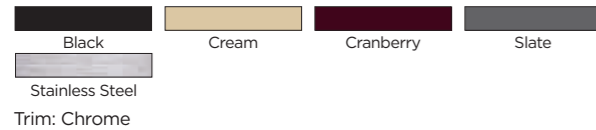

KEY FEATURES

- Large electric single cavity multifunction oven (7 functions) with two fans
- Energy Saving Panel (E.S.P.) to create small multifunction oven (7 functions);
- Integrated grill with pull-out cradle with two pans and two trivets
- Gas hob options:
 - FX/FXP Models: 5 burners, including a multi-ring burner, a wok cradle a Teppanyaki griddle
- Induction hob options:
 - FX Model: 5 cooking zones
- Large storage drawer
- Pyrolytic cleaning (FXP model)

ENERGY SAVING PANEL

Our revolutionary Professional+ FX/FXP range cookers feature a unique energy saving panel (E.S.P.) that allows you to split the oven in half - creating a truly flexible appliance, offering the best of both worlds. The 114 cubic litre (full capacity) oven is ideal for large family dinners, but it can be transformed quickly and easily into a compact, economical single oven for smaller meals.

HOB OPTIONS

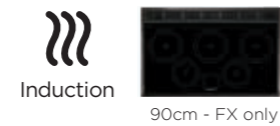

Oven dimensions are for information only; they should not be used to define oven cookware dimensions.

SPECIFICATIONS

Model	PROFESSIONAL+ FX / FXP 90		
Hob fuel type	GAS (DF)	INDUCTION	GAS (DF)
Product code	PROP90FXDF	PROP90FXEI	PROP90FXPDF
Width (mm)	900	900	900
Height to hotplate (mm) min / max	905 / 930	905 / 930	905 / 930
Depth excluding/including handles (mm)	608 / 642	608 / 642	617 / 662
Weight (kg)	122	119	133
Electrical ratings specified at 230VAC	100	185 / 250	100
	170	115 / 200	170
	170	185 / 300	170
	300	115 / 200	300
	350	185 / 250	350
	-	-	-
Multi-zone / Bridging-zone / Dual-purpose zone	-	-	-
Total hob rating (kW)	10.90	7.40	10.90
Single-phase connection (A)	16.09	48.26	16.09
Three-phase connection (A)	3 x 16	3 x 16	3 x 16
Maximum electrical load (kW @ 230V)	3.70	11.12	3.59
Grill power rating (kW)	3.50	3.50	3.50
Separate grill	-	-	-
Oven temperature °C max	240	240	240
Slow cook oven °C max	-	-	-
Dimensions - LH oven (W x H x D)	752 x 377 x 402	752 x 377 x 402	752 x 377 x 402
Capacity - LH oven (litres)	114 (full oven)	114 (full oven)	114 (full oven)
Energy rating - LH oven	A	A	A
Dimensions - RH oven (W x H x D)	363 x 393 x 396	363 x 393 x 396	363 x 393 x 397
Capacity - RH oven (litres)	49 (with E.S.P.)	49 (with E.S.P.)	49 (with E.S.P.)
Energy rating - RH oven	A	A	A
Oven shelves (+1 = Plate rack)	Full: 2 flat With E.S.P.: 3 flat	Full: 2 flat With E.S.P.: 3 flat	Full: 2 flat With E.S.P.: 3 flat
Pan support material	Cast iron / Removable	-	Cast iron / Removable
Timer type	Rotary / White Display	Rotary / White Display	6 Button / Green Display
Oven light	Full: Yes Divided: Yes	Full: Yes Divided: Yes	Full: Yes Divided: Yes
Oven liners: Catalytic (C) / Enamel (E)	Full/Divided: E	Full/Divided: E	Full/Divided: Pyrolytic



LECKFORD DELUXE



110cm



90cm



Trim: Chrome

Oven dimensions are for information only; they should not be used to define oven cookware dimensions.

SPECIFICATIONS

Model	LECKFORD DELUXE 90		LECKFORD DELUXE 110	
Hob fuel type	GAS (DF)	INDUCTION	GAS (DF)	INDUCTION
Product code	LKD90DF	LKD90EI	LKD110DF	LKD110EI
Width (mm)	900	900	1092	1100
Height to hotplate (mm) min / max	905 / 930	905 / 930	905 / 930	905 / 930
Depth excluding/including handles (mm)	605 / 685	605 / 685	605 / 685	605 / 685
Weight (kg)	129	128	142	143
Electrical ratings specified at 230VAC	100	185 / 250	3.00	1.85 / 2.50
	170	185 / 250	1.70	1.85 / 2.50
	170	185 / 320	1.70	1.85 / 3.20
	300	115 / 200	1.00	1.15 / 2.00
	350	185 / 250	3.50	1.85 / 2.50
	-	-	-	-
Multi-zone / Bridging-zone / Dual-purpose zone	-	Bridging-zone	Multi-zone (2 x 1.1kW)	Bridging-zone
Total hob rating (kW)	10.90	7.40	Gas: 10.90 Electric: 2.20	7.40
Single-phase connection (A)	37.39	69.57	47.83	70.43
Three-phase connection (A)	3 x 16	3 x 25	3 x 16	3 x 25
Maximum electrical load (kW @ 230V)	8.60	16.00	11.00	16.20
Grill power rating (kW)	2.30	2.30	2.30	2.30
Separate grill	Glide-out	Glide-out	Glide-out	Glide-out
Oven temperature °C max	240	240	240	240
Slow cook oven °C max	-	-	-	-
Dimensions - LH oven (W x H x D)	467 x 438 x 385	467 x 438 x 385	467 x 438 x 385	467 x 438 x 385
Capacity - LH oven (litres)	79	79	79	79
Energy rating - LH oven	A	A	A	A
Dimensions - RH oven (W x H x D)	297 x 577 x 389	297 x 577 x 389	467 x 438 x 385	467 x 438 x 385
Capacity - RH oven (litres)	67	67	79	79
Energy rating - RH oven	A	A	A	A
Oven shelves (+1 = Plate rack)	LH: 2 Flat - RH: 4 Flat (+1)	LH: 2 Flat - RH: 4 Flat (+1)	LH: 2 Flat - RH: 2 Flat	LH: 2 Flat - RH: 2 Flat
Pan support material	Cast iron / Removable	-	Cast iron / Removable	Cast iron / Removable
Timer type	3 Button/White display	3 Button/White display	3 Button/White display	3 Button/White display
Oven light	LH oven	LH oven	LH oven	LH oven
Oven liners: Catalytic (C) / Enamel (E)	LH: C - RH: E	LH: C - RH: E	LH: C - RH: C	LH: C - RH: C

KEY FEATURES

- Two electric ovens:
 - Programmable multifunction oven (8 functions)
 - Fan oven
- Separate deluxe glide-out grill (dual-circuit) with height-adjustable trivet (4 heights)
- Handyrack
- Gas hob options:
 - 90 Model: 5 burners, including a multi-ring burner, a wok cradle and a half smooth-half grooved griddle
 - 110 Model: 5 burners, including a multi-ring burner, a wok cradle and a ceramic multi-zone with 2 cooking zones and a flat griddle
- Induction hob options:
 - 5 cooking zones, including a large central zone, and a bridging-zone that allows for two of the zones to be used as two separate cooking zones, one large cooking zone or a base for the griddle that comes with the cooker, and three low temperature settings (approx. L1 40°C, L2 70°C, L3 90°C)
- Proving / Storage drawer (110 models)

HOB OPTIONS



PROFESSIONAL DELUXE

KEY FEATURES

- Two electric ovens:
 - Programmable multifunction oven (8 functions)
 - Fan oven
- Separate glide-out grill (dual-circuit) with height-adjustable trivet (4 heights)
- Handyrack
- Gas hob options:
 - 90/100 Models: 5 burners, including a multi-ring burner, a wok cradle and half smooth-half grooved griddle
 - 110 Model: 5 burners, including a multi-ring burner, a wok cradle and a ceramic multi-zone with 2 cooking zones and a flat griddle
- Induction hob options:
 - 5 cooking zones
- Storage drawer (110 models)

HOB OPTIONS

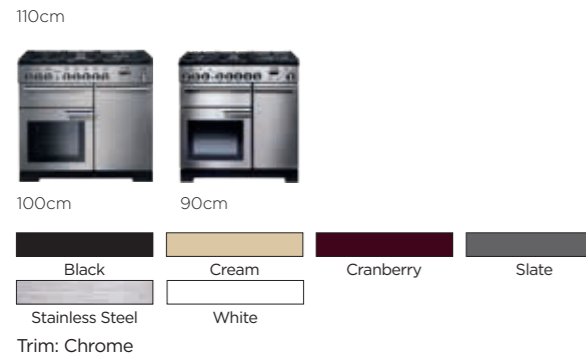
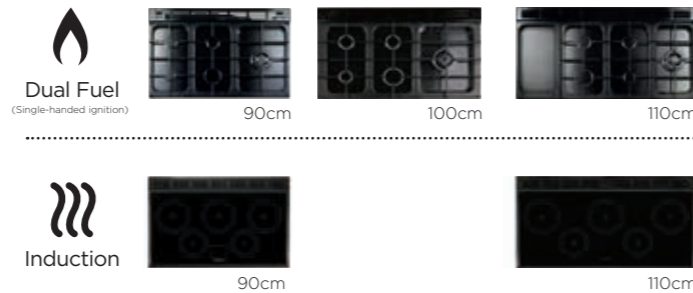

Oven dimensions are for information only; they should not be used to define oven cookware dimensions.

SPECIFICATIONS

Model	PROFESSIONAL DELUXE 90		PROFESSIONAL DELUXE 100		PROFESSIONAL DELUXE 110	
Hob fuel type	GAS (DF)		INDUCTION		GAS (DF)	
Product code	PDL90DF		PDL100DF		PDL110DF	
Width (mm)	900		900		994	
Height to hotplate (mm) min / max	905 / 930		905 / 930		905 / 930	
Depth excluding/including handles (mm)	604 / 649		608 / 649		604 / 645	
Weight (kg)	125		119		127	
Electrical ratings specified at 230VAC	100		185 / 250		100	
	170		115 / 200		170	
	170		185 / 300		170	
	300		115 / 200		300	
	350		185 / 250		350	
	-		-		-	
Multi-zone / Bridging-zone / Dual-purpose zone	-		-		Multi-zone (2 X 11)	
Total hob rating (kW)	1090		740		1090	
Single-phase connection (A)	3739		6957		4783	
Three-phase connection (A)	3 x 16		3 x 25		3 x 16	
Maximum electrical load (kW @ 230V)	8.60		16.00		11.00	
Grill power rating (kW)	2.30		2.30		2.30	
Separate grill	Glide-out		Glide-out		Glide-out	
Oven temperature °C max	240		240		240	
Slow cook oven °C max	-		-		-	
Dimensions - LH oven (W x H x D)	467 x 438 x 385		467 x 438 x 385		467 x 438 x 385	
Capacity - LH oven (litres)	79		79		79	
Energy rating - LH oven	A		A		A	
Dimensions - RH oven (W x H x D)	297 x 577 x 389		297 x 577 x 389		362 x 577 x 389	
Capacity - RH oven (litres)	67		67		82	
Energy rating - RH oven	A		A		A	
Oven shelves (+1 = Plate rack)	LH: 2 Flat - RH: 4 Flat (+1)		LH: 2 Flat - RH: 4 Flat (+1)		LH: 2 Flat - RH: 4 Flat (+1)	
Pan support material	Cast iron / Removable		-		Cast iron / Removable	
Timer type	Rotary / Green display		Rotary / Green display		Rotary / Green display	
Oven light	LH oven		LH oven		Both ovens	
Oven liners: Catalytic (C) / Enamel (E)	LH: C - RH: E		LH: C - RH: E		LH: C - RH: C	

PROFESSIONAL⁺

KEY FEATURES

- Two electric fan ovens, left-hand oven programmable
- Separate glide-out grill (dual-circuit) with height-adjustable trivet (2 heights)
- Handyrack
- Gas hob options:
 - 90/100 Models: 5 burners, including a multi-ring burner, a wok cradle and half smooth-half grooved griddle
 - 110 Model: 6 burners, including a multi-ring burner, a wok cradle and a half smooth-half grooved griddle
- Induction hob options:
 - 5 cooking zones
- Storage drawer (110 models)

HOB OPTIONS

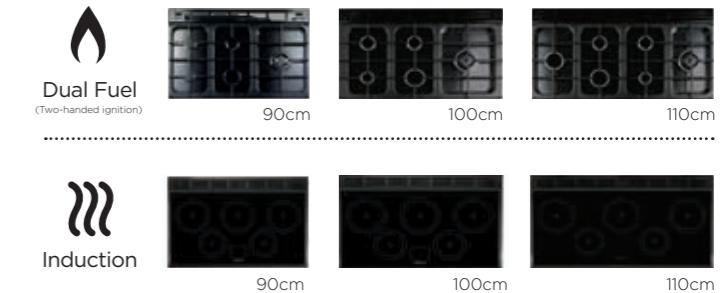

Oven dimensions are for information only; they should not be used to define oven cookware dimensions.

SPECIFICATIONS

Model	PROFESSIONAL ⁺ 90		PROFESSIONAL ⁺ 100		PROFESSIONAL ⁺ 110	
Hob fuel type	GAS (DF)		INDUCTION		GAS (DF)	
Product code	PROP90DF		PROP90EI		PROP100DF	
Width (mm)	900		900		994	
Height to hotplate (mm) min / max	905 / 930		905 / 930		905 / 930	
Depth excluding/including handles (mm)	604 / 642		608 / 645		604 / 642	
Weight (kg)	113		119		123	
Electrical ratings specified at 230VAC	100		115 / 200		100	
	170		185 / 250		170	
	170		185 / 300		170	
	300		115 / 200		300	
	350		185 / 250		350	
	-		-		-	
Multi-zone / Bridging-zone / Dual-purpose zone	-		-		-	
Total hob rating (kW)	1090		740		1090	
Single-phase connection (A)	3217		6435		3217	
Three-phase connection (A)	3 x 16		3 x 25		3 x 25	
Maximum electrical load (kW @ 230V)	7.40		14.80		7.40	
Grill power rating (kW)	2.30		2.30		2.30	
Separate grill	Glide-out		Glide-out		Glide-out	
Oven temperature °C max	240		240		240	
Slow cook oven °C max	-		-		-	
Dimensions - LH oven (W x H x D)	467 x 438 x 385		467 x 438 x 385		467 x 438 x 385	
Capacity - LH oven (litres)	79		79		79	
Energy rating - LH oven	A		A		A	
Dimensions - RH oven (W x H x D)	297 x 577 x 389		297 x 577 x 389		362 x 577 x 389	
Capacity - RH oven (litres)	67		67		82	
Energy rating - RH oven	A		A		A	
Oven shelves (+1 = Plate rack)	LH: 2 Flat - RH: 4 Flat (+1)		LH: 2 Flat - RH: 4 Flat (+1)		LH: 2 Flat - RH: 4 Flat (+1)	
Pan support material	Cast iron / Removable		-		Cast iron / Removable	
Timer type	Rotary / Green display		Rotary / Green display		Rotary / Green display	
Oven light	LH Oven		LH Oven		Both ovens	
Oven liners: Catalytic (C) / Enamel (E)	LH: C - RH: E		LH: C - RH: E		LH: C - RH: C	

CLASSIC DELUXE



110cm



100cm

90cm



KEY FEATURES

- Two electric ovens:
 - Programmable multifunction oven (8 functions)
 - Fan oven
- Handyrack
- Separate deluxe glide-out grill (dual-circuit) with height-adjustable trivet (4 heights)
- Gas hob options:
 - 90/100 Models: 5 burners, including a multi-ring burner, a half smooth-half grooved griddle and a wok cradle
 - 110 Models: 5 burners, including a multi-ring burner, a wok cradle and a ceramic multi-zone with 2 cooking zones and a griddle
- Ceramic hob options:
 - 90 Model: 5 cooking zones
 - 110 Model: 5 cooking zones and a dual-purpose zone containing an additional cooking zone and 2 warming zones
- Induction hob options:
 - 5 cooking zones
- Rapid Response
- Proving / Storage drawer
- Detachable mini splashback

HOB OPTIONS

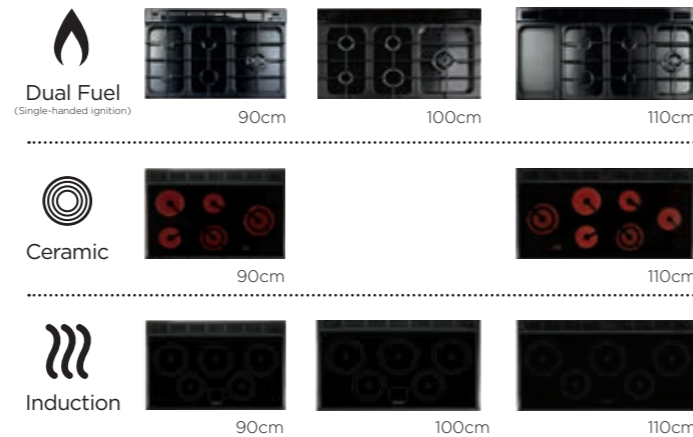

Oven dimensions are for information only; they should not be used to define oven cookware dimensions.

SPECIFICATIONS

Model	CLASSIC DELUXE 90			CLASSIC DELUXE 100		CLASSIC DELUXE 110		
	GAS (DF)	CERAMIC	INDUCTION	GAS (DF)	INDUCTION	GAS (DF)	CERAMIC	INDUCTION
Product code	CDL90DF	CDL90EC	CDL90EI	CDL100DF	CDL100EI	CDL110DF	CDL110EC	CDL110EI
Width (mm)	900	900	900	994	994	1092	1100	1100
Height to hotplate (mm) min / max	905 / 930	905 / 930	905 / 930	905 / 930	905 / 930	905 / 930	905 / 930	905 / 930
Depth excluding/including handles (mm)	608 / 670	608 / 670	608 / 670	608 / 670	608 / 670	608 / 670	608 / 670	608 / 670
Weight (kg)	124	109	125	134	126	144	133	140
Electrical ratings specified at 230VAC	100	110	115 / 200	100	115 / 200	300	110	185 / 250
	170	165	185 / 250	170	185 / 250	170	202	115 / 200
	170	110	185 / 300	170	185 / 300	170	165	185 / 300
	300	202	115 / 200	300	185 / 250	350	110	115 / 200
	350	156	185 / 250	350	115 / 200	100	110	185 / 250
	-	-	-	-	-	-	156	-
Multi-zone / Bridging-zone / Dual-purpose zone	-	-	-	-	-	Multi-zone (2 x 1.10)	Dual-Purpose (2 x 0.03)	-
Total hob rating (kW)	1090	743	740	1090	740	1090	859	740
Single-phase connection (A)	3739	6435	6957	3739	6957	4783	7565	7043
Three-phase connection (A)	3 x 16	3 x 25	3 x 25	3 x 16	3 x 16	3 x 16	3 x 25	3 x 25
Maximum electrical load (kW @ 230V)	8.60	14.80	16.00	8.60	16.00	11.00	17.40	16.20
Grill power rating (kW)	230	230	230	230	230	230	230	230
Separate grill	Glide-out	Glide-out	Glide-out	Glide-out	Glide-out	Glide-out	Glide-out	Glide-out
Oven temperature °C max	240	240	240	240	240	240	240	240
Slow cook oven °C max	-	-	-	-	-	-	-	-
Dimensions - LH oven (W x H x D)	467 x 438 x 385	467 x 438 x 385	467 x 438 x 385	467 x 438 x 385	467 x 438 x 385	467 x 438 x 385	467 x 438 x 385	467 x 438 x 385
Capacity - LH oven (litres)	79	79	79	79	79	79	79	79
Energy rating - LH oven	A	A	A	A	A	A	A	A
Dimensions - RH oven (W x H x D)	297 x 577 x 389	297 x 577 x 389	297 x 577 x 389	362 x 577 x 389	362 x 577 x 389	467 x 438 x 385	467 x 438 x 385	467 x 438 x 385
Capacity - RH oven (litres)	67	67	67	82	82	79	79	79
Energy rating - RH oven	A	A	A	A	A	A	A	A
Oven shelves (+1 = Plate rack)	LH: 2 Flat RH: 4 Flat (+1)	LH: 2 Flat RH: 4 Flat (+1)	LH: 2 Flat RH: 4 Flat (+1)	LH: 2 Flat RH: 4 Flat (+1)	LH: 2 Flat RH: 4 Flat (+1)	LH: 2 Flat RH: 2 Flat	LH: 2 Flat RH: 2 Flat	LH: 2 Flat RH: 2 Flat
Pan support material	Cast iron / Removable	-	-	Cast iron / Removable	-	Cast iron / Removable	-	Cast iron / Removable
Timer type	6 Button Green display	6 Button Green display	6 Button Green display	6 Button Green display	6 Button Green display	6 Button Green display	6 Button Green display	6 Button Green display
Oven light	LH oven	LH oven	LH oven	LH oven	LH oven	Both ovens	Both ovens	Both ovens
Oven liners: Catalytic (C) / Enamel (E)	LH: C - RH: E	LH: C - RH: E	LH: C - RH: E	LH: C - RH: E	LH: C - RH: E	LH: C - RH: C	LH: C - RH: C	LH: C - RH: C

CLASSIC



110cm



100cm

90cm

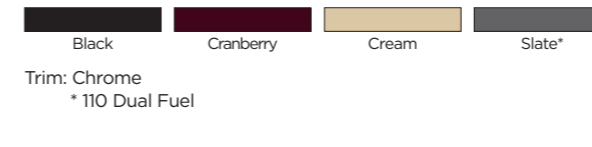

Oven dimensions are for information only; they should not be used to define oven cookware dimensions.

SPECIFICATIONS

Model	CLASSIC 90			CLASSIC 100		CLASSIC 110		
	GAS (DF)	CERAMIC	INDUCTION	GAS (DF)	INDUCTION	GAS (DF)	CERAMIC	INDUCTION
Product code	CLAS90DF	CLAS90EC	CLAS90EI	CLAS100DF	CLAS100EI	CLAS110DF	CLAS110EC	CLAS110EI
Width (mm)	900	900	900	994	994	1092	1100	1100
Height to hotplate (mm) min / max	905 / 930	905 / 930	905 / 930	905 / 930	905 / 930	905 / 930	905 / 930	905 / 930
Depth excluding/including handles (mm)	608 / 670	608 / 670	608 / 670	608 / 670	608 / 670	608 / 670	608 / 670	608 / 670
Weight (kg)	111	105	116	120	114	120	112	131
Electrical ratings specified at 230VAC	100	165	115 / 200	100	115 / 200	300	202	115 / 200
	170	165	115 / 200	170	185 / 250	300	165	185 / 250
	170	110	185 / 300	170	185 / 300	170	110	185 / 300
	300	110	115 / 200	170	185 / 250	170	110	185 / 250
	350	202	185 / 250	100	115 / 200	350	156	115 / 200
	-	-	-	-	-	350	2 X 0.03	-
Multi-zone / Bridging-zone / Dual-purpose zone	-	-	-	-	-	-	Dual-purpose	-
Total hob rating (kW)	1090	743	740	1090	740	1390	859	740
Single-phase connection (A)	3217	6435	6435	3217	6435	3230	6974	6448
Three-phase connection (A)	3 x 16	3 x 25	3 x 25	3 x 16	3 x 25	3 x 25	3 x 25	3 x 25
Maximum electrical load (kW @ 230V)	7.40	14.80	14.80	7.40	14.80	7.43	16.04	14.83
Grill power rating (kW)	230	230	230	230	230	230	230	230
Separate grill	Glide-out	Glide-out	Glide-out	Glide-out	Glide-out	Glide-out	Glide-out	Glide-out
Oven temperature °C max	240	240	240	240	240	240	240	240
Slow cook oven °C max	-	-	-	-	-	-	-	-
Dimensions - LH oven (W x H x D)	467 x 438 x 385	467 x 438 x 385	467 x 438 x 385	467 x 438 x 385	467 x 438 x 385	467 x 438 x 385	467 x 438 x 385	467 x 438 x 385
Capacity - LH oven (litres)	79	79	79	79	79	79	79	79
Energy rating - LH oven	A	A	A	A	A	A	A	A
Dimensions - RH oven (W x H x D)	297 x 577 x 389	297 x 577 x 389	297 x 577 x 389	362 x 577 x 389	362 x 577 x 389	467 x 438 x 385	467 x 438 x 385	467 x 438 x 385
Capacity - RH oven (litres)	67	67	67	82	82	79	79	79
Energy rating - RH oven	A	A	A	A	A	A	A	A
Oven shelves (+1 = Plate rack)	LH: 2 Flat RH: 4 Flat (+1)	LH: 2 Flat RH: 4 Flat (+1)	LH: 2 Flat RH: 4 Flat (+1)	LH: 2 Flat RH: 4 Flat (+1)	LH: 2 Flat RH: 4 Flat (+1)	LH: 2 Flat RH: 2 Flat	LH: 2 Flat RH: 2 Flat	LH: 2 Flat RH: 2 Flat
Pan support material	Cast iron / Removable	-	-	Cast iron / Removable	-	Cast iron / Removable	-	-
Timer type	3 Button/Red display	3 Button/Red display	3 Button/Red display	3 Button/Red display	3 Button/Red display	3 Button/Red display	3 Button/Red display	3 Button/Red display
Oven light	LH oven	LH oven	LH oven	LH oven	LH oven	Both ovens	Both ovens	Both ovens
Oven liners: Catalytic (C) / Enamel (E)	LH: C - RH: E	LH: C - RH: E	LH: C - RH: E	LH: C - RH: E	LH: C - RH: E	LH: C - RH: C	LH: C - RH: C	LH: C - RH: C

KEY FEATURES

- Two electric fan ovens, left-hand oven programmable
- Handyrack
- Separate glide-out grill (dual-circuit) with height-adjustable trivet (2 heights)
- Gas hob options:
 - 90/100 Models: 5 burners, including a multi-ring burner, and a half smooth-half grooved griddle
 - 110 Models: 6 burners, including a multi-ring burner, and a half smooth-half grooved griddle
- Ceramic hob options:
 - 90 Model: 5 cooking zones
 - 110 Model: 5 cooking zones and a ceramic dual-purpose zone with a 1.1kW cooking zone and 2 warming zones
- Induction hob options:
 - 5 cooking zones
- Storage drawer (110 models)
- Detachable mini splashback

HOB OPTIONS

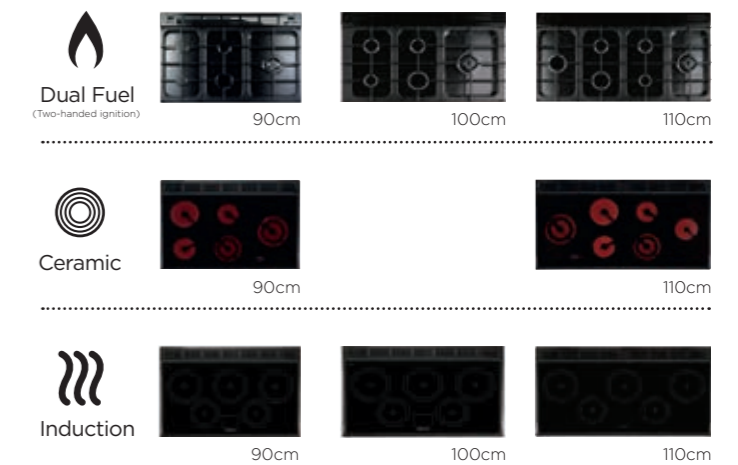

ESPRIT



110cm



Trim: Chrome

KEY FEATURES

- Two electric fan ovens, left-hand oven programmable
- Thermostatically controlled slow cook oven (80°C - 140°C)
- Separate glide-out grill (dual-circuit) with height-adjustable trivet (2 heights)
- Gas hob options:
 - 6 burners, including a multi-ring burner
- Induction hob options:
 - 5 cooking zones with two low temperature settings
- Colour co-ordinated fascia
- Easily removable, single-piece magnetic plinth

HOB OPTIONS



110cm



110cm

INFUSION



110cm



90cm



Trim: Chrome

KEY FEATURES

- Two electric fan ovens, left-hand oven programmable
- Separate glide-out grill (dual-circuit) with height-adjustable trivet (2 heights)
- Gas hob options:
 - 90 Model: 5 burners, including a multi-ring burner, and a Teppanyaki griddle
 - 110 Model: 6 burners, including a multi-ring burner, and a Teppanyaki griddle
- Induction hob options:
 - 5 cooking zones
- Storage drawer (110 models)

HOB OPTIONS



90cm



110cm



90cm



110cm

Oven dimensions are for information only; they should not be used to define oven cookware dimensions.

SPECIFICATIONS

Model	ESPRIT 110	
	GAS (DF)	INDUCTION
Hob fuel type	GAS (DF)	INDUCTION
Product code	ESPI0DF	ESPI0EI
Width (mm)	1092	1100
Height to hotplate (mm) min / max	905 / 930	905 / 930
Depth excluding/including handles (mm)	604 / 642	608 / 646
Weight (kg)	142	148
Electrical ratings specified at 230VAC	3.00	1.85 / 2.50
	3.00	1.15 / 2.00
	1.70	1.85 / 3.00
	1.70	1.15 / 2.00
	1.00	1.85 / 2.50
	3.50	-
Multi-zone / Bridging-zone / Dual-purpose zone	-	-
Total hob rating (kW)	13.90	7.40
Single-phase connection (A)	36.96	15.80
Three-phase connection (A)	3 x 16	3 x 25
Maximum electrical load (kW @ 230V)	36.96	68.70
Grill power rating (kW)	2.30	2.30
Separate grill	Glide-out	Glide-out
Oven temperature °C max	140	140
Slow cook oven °C max	Yes	-
Dimensions - LH oven (W x H x D)	467 x 438 x 385	467 x 438 x 385
Capacity - LH oven (litres)	79	79
Energy rating - LH oven	A	A
Dimensions - RH oven (W x H x D)	467 x 438 x 385	467 x 438 x 385
Capacity - RH oven (litres)	79	79
Energy rating - RH oven	A	A
Oven shelves (+1 = Plate rack)	LH: 2 Flat - RH: 2 Flat	LH: 2 Flat - RH: 2 Flat
Pan support material	Cast iron / Removable	-
Timer type	3 Button/Red display	3 Button/Red display
Oven light	Both ovens	Both ovens
Oven liners: Catalytic (C) / Enamel (E)	LH: C - RH: C	LH: C - RH: C



Oven dimensions are for information only; they should not be used to define oven cookware dimensions.

SPECIFICATIONS

Model	INFUSION 90		INFUSION 110	
	GAS (DF)	INDUCTION	GAS (DF)	INDUCTION
Hob fuel type	GAS (DF)	INDUCTION	GAS (DF)	INDUCTION
Product code	INF90DF	INF90EI	INF10DF	INF10EI
Width (mm)	900	900	1092	1100
Height to hotplate (mm) min / max	905 / 930	905 / 930	905 / 930	905 / 930
Depth excluding/including handles (mm)	604 / 652	608 / 656	604 / 652	608 / 656
Weight (kg)	113	113	133	128
Electrical ratings specified at 230VAC	1.00	1.85 / 2.50	3.00	1.85 / 2.50
	1.70	1.85 / 3.00	3.00	1.15 / 2.00
	1.70	3.00	1.70	1.85 / 3.00
	3.00	1.15 / 2.00	1.70	1.85
	3.50	1.15	1.00	1.85 / 2.50
	-	-	3.50	-
Multi-zone / Bridging-zone / Dual-purpose zone	-	-	-	-
Total hob rating (kW)	10.90	7.40	13.90	7.40
Single-phase connection (A)	32.17	64.35	32.30	64.48
Three-phase connection (A)	3 x 16	3 x 25	3 x 25	3 x 25
Maximum electrical load (kW @ 230V)	7.40	14.80	7.43	14.83
Grill power rating (kW)	2.30	2.30	2.30	2.30
Separate grill	Glide-out	Glide-out	Glide-out	Glide-out
Oven temperature °C max	240	240	240	240
Slow cook oven °C max	-	-	-	-
Dimensions - LH oven (W x H x D)	467 x 438 x 385	467 x 438 x 385	467 x 438 x 385	467 x 438 x 385
Capacity - LH oven (litres)	79	79	79	79
Energy rating - LH oven	A	A	A	A
Dimensions - RH oven (W x H x D)	297 x 577 x 389	297 x 577 x 389	467 x 438 x 385	467 x 438 x 385
Capacity - RH oven (litres)	67	67	79	79
Energy rating - RH oven	A	A	A	A
Oven shelves (+1 = Plate rack)	LH: 2 Flat, 1 Telescopic RH: 4 Flat (+1)	LH: 2 Flat, 1 Telescopic RH: 4 Flat (+1)	LH: 2 Flat, 1 Telescopic RH: 2 Flat	LH: 2 Flat, 1 Telescopic RH: 2 Flat
Pan support material	Cast iron / Removable	-	Cast iron / Removable	-
Timer type	3 Button / Red display	3 Button / Red display	3 Button / Red display	3 Button / Red display
Oven light	RH oven	RH oven	Both ovens	Both ovens
Oven liners: Catalytic (C) / Enamel (E)	LH: C - RH: E	LH: C - RH: E	LH: C - RH: C	LH: C - RH: C

KITCHENER



90cm



100cm

110cm



Black

Cream

Stainless Steel

Trim: Chrome

KEY FEATURES

- Two electric fan ovens; left-hand oven programmable
- Handyrack
- Separate glide-out grill (dual-circuit) with height-adjustable trivet (2 heights)
- Gas hob options:
 - 90/100 Models: 5 burners, including a multi-ring burner
 - 110 Model: 6 burners, including a multi-ring burner
- Storage drawer (110 model)

HOB OPTIONS



Dual Fuel
(Double-handed ignition)



90cm



100cm



110cm

Oven dimensions are for information only; they should not be used to define oven cookware dimensions.

Oven dimensions are for information only; they should not be used to define oven cookware dimensions.

SPECIFICATIONS

Model	KITCHENER 90	KITCHENER 100	KITCHENER 110
Hob fuel type	GAS (DF)	GAS (DF)	GAS (DF)
Product code	KCH90DF	KCH100DF	KCH110DF
Width (mm)	900	994	1092
Height to hotplate (mm) min / max	905 / 930	905 / 930	905 / 930
Depth excluding/including handles (mm)	604 / 652	604 / 652	604 / 652
Weight (kg)	102	118	129
Electrical ratings specified at 230VAC	100	100	300
	170	170	300
	170	170	170
	300	300	170
	350	350	100
	-	-	350
Multi-zone / Bridging-zone / Dual-purpose zone	-	-	-
Total hob rating (kW)	10.90	10.90	13.90
Single-phase connection (A)	3217	3217	3230
Three-phase connection (A)	3 x 16	3 x 16	3 x 16
Maximum electrical load (kW @ 230V)	7.40	7.40	7.43
Grill power rating (kW)	2.30	2.30	2.30
Separate grill	Glide-out	Glide-out	Glide-out
Oven temperature °C max	240	240	240
Slow cook oven °C max	-	-	-
Dimensions - LH oven (W x H x D)	467 x 438 x 385	467 x 438 x 385	467 x 438 x 385
Capacity - LH oven (litres)	79	79	79
Energy rating - LH oven	A	A	A
Dimensions - RH oven (W x H x D)	297 x 577 x 389	362 x 577 x 389	467 x 438 x 385
Capacity - RH oven (litres)	67	82	79
Energy rating - RH oven	A	A	A
Oven shelves (+1 = Plate rack)	LH: 2 Flat - RH: 4 Flat (+1)	LH: 2 Flat - RH: 4 Flat (+1)	LH: 2 Flat - RH: 2 Flat
Pan support material	Cast iron / Removable	Cast iron / Removable	Cast iron / Removable
Timer type	6 Button / Green display	6 Button / Green display	6 Button / Green display
Oven light	LH oven	LH oven	Both ovens
Oven liners: Catalytic (C) / Enamel (E)	LH: C - RH: E	LH: C - RH: E	LH: C - RH: C

Choosing your COOKER...



900S



Continental



Deluxe



Mercury

SEMI-PROFESSIONAL RANGE

As the star of your kitchen, a Falcon range cooker is not only built to perform, it's designed to look the part too. Our Semi-Professional range is at the pinnacle of engineering brilliance and continually sets out to inspire the passion in you. Falcon Semi-Professional cookers are modern masterpieces; they are made from thick 1.2mm gauge stainless steel, and the burners are solid brass and in one piece for easy cleaning. They have long set the professional standard, both at home and in the commercial environment, and are designed to offer the best cooking experience.

MERCURY



KEY FEATURES

- Two electric ovens:
 - Multifunction oven (8 functions)
 - Fan oven
- Separate, robust deluxe glide-out grill (dual-circuit) with height-adjustable trivet (4 ways)
- Gas hob options:
 - 5 brass burners, including a large 5kW burner, and a wok cradle
- Induction hob options:
 - 5 cooking zones
- Heavy-duty oven shelves
- 1200 Models: Push-to-open, soft-close storage drawer with anti-slip mat
- Removable base liner (1000/1082: multifunction oven; 1200: both ovens)
- Induction model: powerful, faster, more efficient
- Full stainless steel side panels
- Cast lettering branding
- Optional extras: Premium griddle (dual fuel models)

HOB OPTIONS

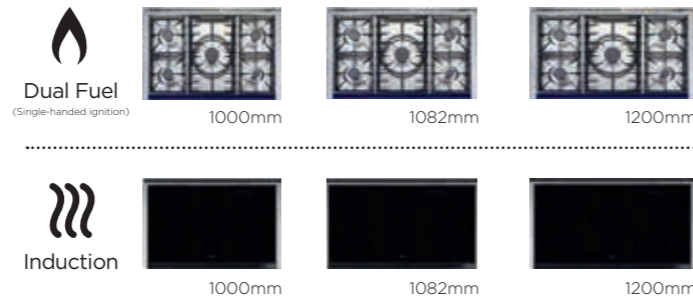

Trim: Polished Stainless Steel

Oven dimensions are for information only; they should not be used to define oven cookware dimensions.

SPECIFICATIONS

Model	MERCURY 1000		MERCURY 1082		MERCURY 1200	
	GAS (DF)	INDUCTION	GAS (DF)	INDUCTION	GAS (DF)	INDUCTION
Product code	MCY1000DF	MCY1000EI	MCY1082DF	MCY1082EI	MCY1200DF	MCY1200EI
Width (mm)	990	990	1082	1082	1190	1190
Height to hotplate (mm) min / max	920 / 945	920 / 945	920 / 945	920 / 945	920 / 945	920 / 945
Depth excluding/including handles (mm)	638 / 700	638 / 700	638 / 700	638 / 700	638 / 700	638 / 700
Weight (kg)	155	143	163	155	178	174
Electrical ratings specified at 230VAC	3.00	1.85 / 3.00	3.00	1.85 / 3.00	3.00	1.85 / 3.00
	3.00	1.40 / 2.20	3.00	1.40 / 2.20	5.00	1.40 / 2.20
	3.00	2.30 / 3.70	5.00	2.30 / 3.70	3.00	2.30 / 3.70
	5.00	1.85 / 3.00	3.00	1.85 / 3.00	3.00	1.85 / 3.00
	1.70	1.85 / 3.00	1.70	1.85 / 3.00	1.70	1.85 / 3.00
	-	-	-	-	-	-
Multi-zone / Bridging-zone / Dual-purpose zone	-	110	-	110	-	110
Total hob rating (kW)	15.70	9.25 / 14.90	15.70	9.25 / 14.90	15.70	9.25 / 14.90
Single-phase connection (A)	3217	-	3217	-	3217	-
Three-phase connection (A)	3 x 16	3 x 25	3 x 16	3 x 25	3 x 16	3 x 25
Maximum electrical load (kW @ 230V)	740	18.50	740	18.50	740	18.50
Grill power rating (kW)	2.30	2.30	2.30	2.30	2.30	2.30
Separate grill	Glide-out	Glide-out	Glide-out	Glide-out	Glide-out	Glide-out
Oven temperature °C max	240	240	240	240	240	240
Slow cook oven °C max	-	-	-	-	-	-
Dimensions - LH oven (W x H x D)	467 x 438 x 385	467 x 438 x 385	467 x 438 x 385	467 x 438 x 385	467 x 438 x 385	467 x 438 x 385
Capacity - LH oven (litres)	79	79	79	79	79	79
Energy rating - LH oven	A	A	A	A	A	A
Dimensions - RH oven (W x H x D)	297 x 577 x 389	297 x 577 x 389	362 x 577 x 389	362 x 577 x 389	467 x 438 x 385	467 x 438 x 385
Capacity - RH oven (litres)	69	69	82	82	79	79
Energy rating - RH oven	A	A	A	A	A	A
Oven shelves (+1 = Plate rack)	LH: 1 Telescopic, 1 flat, 1 drop - RH: 4 flat(+1)	LH: 1 Telescopic, 1 flat, 1 drop - RH: 4 flat(+1)	LH: 1 Telescopic, 1 flat, 1 drop - RH: 4 flat(+1)	LH: 1 Telescopic, 1 flat, 1 drop - RH: 4 flat(+1)	LH: 1 Telescopic, 1 flat, 1 drop - RH: 2 flat	LH: 1 Telescopic, 1 flat, 1 drop - RH: 2 flat
Pan support material	Cast iron / Removable	-	Cast iron / Removable	-	Cast iron / Removable	-
Timer type	-	-	-	-	-	-
Oven light	-	-	-	-	-	-
Oven liners: Catalytic (C) / Enamel (E)	LH: C - RH: E	LH: C - RH: E	LH: C - RH: E	LH: C - RH: E	LH: C - RH: C	LH: C - RH: C

DELUXE



KEY FEATURES

- Two electric ovens:
 - Multifunction oven (7 functions)
 - Fan oven
- Separate deluxe glide-out grill (dual-circuit) with height-adjustable trivet (4 heights)
- Gas hob options:
 - 5 burners, including a 5kW industrial strength burner, and a wok cradle
- Induction hob options:
 - 5 cooking zones, including a powerful 3.7kW central zone
- 110 Models: Storage drawer with anti-slip mat
- Professional-quality oven shelves with lock system
- Removable base liner (900/1000: multifunction oven; 1092: both ovens)
- Dual Fuel models: Premium, enhanced stainless steel one-piece hotplate
- Durable ink injected control panel graphics

HOB OPTIONS

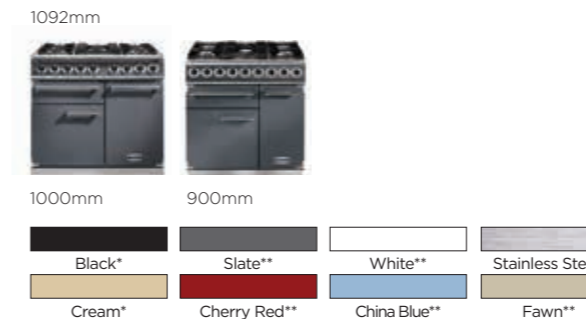
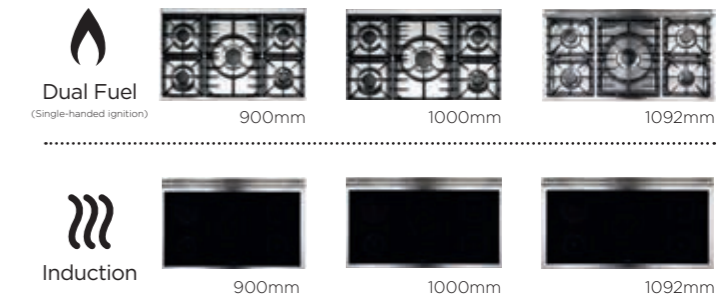

Trim: * Chrome
** Brushed Nickel

Oven dimensions are for information only; they should not be used to define oven cookware dimensions.

SPECIFICATIONS

Model	900 DELUXE		1000 DELUXE		1092 DELUXE	
	GAS (DF)	INDUCTION	GAS (DF)	INDUCTION	GAS (DF)	INDUCTION
Product code	F900DXDF	F900DXEI	F1000DXDF	F1000DXEI	F1092DXDF	F1092DXEI
Width (mm)	900	900	990	990	1092	1092
Height to hotplate (mm) min / max	912 / 937	912 / 937	912 / 937	912 / 937	912 / 937	915 / 942
Depth excluding/including handles (mm)	600 / 660	600 / 660	600 / 660	600 / 660	600 / 660	600 / 660
Weight (kg)	131	133	138	132	144	141
Electrical ratings specified at 230VAC	3.00	1.85 / 3.00	3.00	1.85 / 3.00	3.00	1.85 / 3.00
	3.00	1.40 / 2.20	5.00	1.40 / 2.20	3.00	1.40 / 2.20
	5.00	2.30 / 3.70	3.00	2.30 / 3.70	5.00	2.30 / 3.70
	3.00	1.85 / 3.00	3.00	1.85 / 3.00	3.00	1.85 / 3.00
	1.70	1.85 / 3.00	1.70	1.85 / 3.00	1.70	1.85 / 3.00
	-	-	-	-	-	-
Multi-zone / Bridging-zone / Dual-purpose zone	-	-	-	-	-	-
Total hob rating (kW)	15.70	11.0	15.70	11.0	15.70	11.0
Single-phase connection (A)	3217	8043	3217	8043	3217	8043
Three-phase connection (A)	3 x 16	3 x 25	3 x 16	3 x 25	3 x 16	3 x 25
Maximum electrical load (kW @ 230V)	740	18.50	740	18.50	740	18.50
Grill power rating (kW)	2.30	2.30	2.30	2.30	2.30	2.30
Separate grill	Glide-out	Glide-out	Glide-out	Glide-out	Glide-out	Glide-out
Oven temperature °C max	240	240	240	240	240	240
Slow cook oven °C max	-	-	-	-	-	-
Dimensions - LH oven (W x H x D)	467 x 438 x 385	467 x 438 x 385	467 x 438 x 385	467 x 438 x 385	467 x 438 x 385	467 x 438 x 385
Capacity - LH oven (litres)	79	79	79	79	79	79
Energy rating - LH oven	A	A	A	A	A	A
Dimensions - RH oven (W x H x D)	297 x 577 x 389	297 x 577 x 389	362 x 577 x 389	362 x 577 x 389	467 x 438 x 385	467 x 438 x 385
Capacity - RH oven (litres)	67	67	82	82	79	79
Energy rating - RH oven	A	A	A	A	A	A
Oven shelves (+1 = Plate rack)	LH: 2 Flat + 1 Drop RH: 4 Flat (+1)	LH: 2 Flat + 1 Drop RH: 4 Flat (+1)	LH: 2 Flat + 1 Drop RH: 4 Flat (+1)	LH: 2 Flat + 1 Drop RH: 4 Flat (+1)	LH: 2 Flat + 1 Drop RH: 2 Flat	LH: 2 Flat + 1 Drop RH: 2 Flat
Pan support material	Cast iron / Removable	-	Cast iron / Removable	-	Cast iron / Removable	-
Timer type	-	-	-	-	-	-
Oven light	-	-	-	-	-	-
Oven liners: Catalytic (C) / Enamel (E)	LH: C - RH: E	LH: C - RH: E	LH: C - RH: E	LH: C - RH: E	LH: C - RH: C	LH: C - RH: C

CONTINENTAL



1092mm

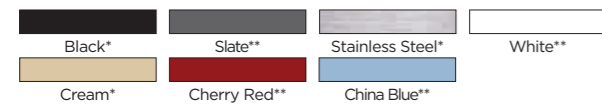

Trim: * Chrome
** Brushed Nickel

KEY FEATURES

- Two electric ovens:
 - Multifunction oven (7 functions)
 - Fan oven
- Professional-quality oven shelves with lock system
- Deluxe oven tray (grilling/oven cooking) with height-adjustable trivet (2 heights)
- Integrated, full oven width grill
- Gas hob options:
 - Premium, enhanced stainless steel one-piece hotplate with 5 one-piece bolted professional brass burners, including a large 5kW multi-ring burner, and a wok cradle
- Induction hob options:
 - 5 cooking zones with power boost
- Individual, dishwasher safe, cast iron pan supports (dual fuel model)
- Full cooker width storage drawer
- Durable ink injected graphics on control panel

HOB OPTIONS

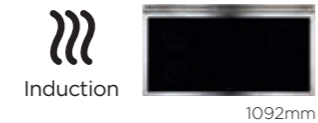

900S



900mm

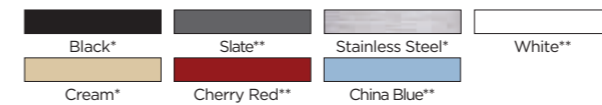

Trim: * Chrome
** Brushed Chrome

KEY FEATURES

- Large single cavity, electric multifunction oven (7 functions) with two fans
- Catalytic-lined energy saving panel (E.S.P.)
- Professional-quality oven shelves with lock system
- Oven tray (grilling/oven cooking) with 2 individual grill pans with height-adjustable trivets (2 heights)
- Integrated, full oven width grill
- Gas hob options:
 - Premium, enhanced stainless steel one-piece hotplate with 5 one-piece bolted professional brass burners, including a large 5kW multi-ring burner, and a wok cradle
- Induction hob options:
 - 5 cooking zones with power boost
- Individual, dishwasher safe, cast iron pan supports (dual fuel model)
- Full cooker width storage drawer
- Durable ink injected graphics on control panel

HOB OPTIONS



Oven dimensions are for information only; they should not be used to define oven cookware dimensions.

SPECIFICATIONS

Model	1092 CONTINENTAL	
	GAS (DF)	INDUCTION
Hob fuel type	GAS (DF)	INDUCTION
Product code	FCON1092DF	FCON1092EI
Width (mm)	1092	1092
Height to hotplate (mm) min / max	600 / 660	600 / 660
Depth excluding/including handles (mm)	912 / 937	915 / 942
Weight (kg)	158	134
Electrical ratings specified at 230VAC	3.00	1.85/3.00
	3.00	1.40/2.20
	5.00	2.30/3.70
	3.00	1.85/3.00
	1.70	1.85/3.00
	-	-
Multi-zone / Bridging-zone / Dual-purpose zone	-	-
Total hob rating (kW)	15.70	11.0
Single-phase connection (A)	2217	70.43
Three-phase connection (A)	3 x 16	3 x 25
Maximum electrical load (kW @ 230V)	5.10	16.20
Grill power rating (kW)	2.35	2.35
Separate grill	-	-
Oven temperature °C max	240	240
Slow cook oven °C max	-	-
Dimensions - LH oven (W x H x D)	467 x 438 x 385	467 x 438 x 385
Capacity - LH oven (litres)	79	79
Energy rating - LH oven	A	A
Dimensions - RH oven (W x H x D)	467 x 438 x 385	467 x 438 x 385
Capacity - RH oven (litres)	79	79
Energy rating - RH oven	A	A
Oven shelves (+1 = Plate rack)	LH: 2 Flat + Tray - RH: 2 Flat	LH: 2 Flat + Tray-RH: 2 Flat
Pan support material	Cast iron / Removable	-
Timer type	-	-
Oven light	Both ovens	Both ovens
Oven liners: Catalytic (C) / Enamel (E)	LH: C - RH: C	LH: C - RH: C



Oven dimensions are for information only; they should not be used to define oven cookware dimensions.

SPECIFICATIONS

Model	900S	
	GAS (DF)	INDUCTION
Hob fuel type	GAS (DF)	INDUCTION
Product code	F900SDF	F900SEI
Width (mm)	900	900
Height to hotplate (mm) min / max	912 / 937	912 / 937
Depth excluding/including handles (mm)	600 / 660	600 / 660
Weight (kg)	151	147
Electrical ratings specified at 230VAC	3.00	1.85 / 3.00
	3.00	1.40 / 2.20
	5.00	2.30 / 3.70
	3.00	1.85 / 3.00
	1.70	1.85 / 3.00
	-	-
Multi-zone / Bridging-zone / Dual-purpose zone	-	-
Total hob rating (kW)	15.70	11.0
Single-phase connection (A)	15.65	54.00
Three-phase connection (A)	3 x 25	3 x 25
Maximum electrical load (kW @ 230V)	3.60	14.80
Grill power rating (kW)	3.50	3.50
Separate grill	-	-
Oven temperature °C max	240	240
Slow cook oven °C max	-	-
Dimensions - LH oven (W x H x D)	-	-
Capacity - LH oven (litres)	114 (full oven)	114 (full oven)
Energy rating - LH oven	A	A
Dimensions - RH oven (W x H x D)	752 x 377 x 402	752 x 377 x 402
Capacity - RH oven (litres)	49 (with ESP)	49 (with ESP)
Energy rating - RH oven	A	A
Oven shelves (+1 = Plate rack)	Full: 1 Flat + 2 Pan oven tray / ESP: 3 Flat	Full: 1 Flat + 2 Pan oven tray / ESP: 3 Flat
Pan support material	Cast iron / Removable	-
Timer type	Full + With ESP.	Full + With ESP.
Oven light	Full + With ESP.	Full + With ESP.
Oven liners: Catalytic (C) / Enamel (E)	Full: C - With ESP: C	Full: C - With ESP: C



With E.S.P.



Single oven

HOOD COLLECTION

CONTEMPORARY / TRADITIONAL / INTEGRATED HOODS

CLASSIC CHIMNEY HOOD

- Recirculation / Ducted hood
- Available in 90cm, 100cm and 110cm
- Three speed settings
- Slider controls
- Activated charcoal and dishwasher safe metal grease filters included
- Two LED lights



*90cm/110cm models: Chrome or brass badge and rail

FALCON HOOD

- Recirculation / Ducted hood
- Available in 90cm, 100cm and 110cm
- Three speed settings
- Slider controls
- Activated charcoal and dishwasher safe metal grease filters included
- Two LED lights



Stainless Steel

* 90cm/110cm: Chrome or brass badge
**110cm only + Chrome / White badge

FALCON PLUS HOOD

- Recirculation / Ducted hood
- Available in 90cm and 110cm
- Three speed settings plus intensive (boost) mode
- Push button controls
- Activated charcoal and dishwasher safe metal grease filters included
- Two LED lights



*Chrome or brass badge

FLAT HOOD

- Recirculation / Ducted hood
- Available in 90cm, 100cm and 110cm
- Three speed settings plus intensive (boost) mode
- Push button controls
- Activated charcoal and dishwasher safe metal grease filters included
- Two LED lights



White Stainless Steel

INTEGRATED HOODS

INTEGRATED HOOD - 720mm

- Recirculation / Ducted hood
- Three speed settings plus intensive (boost) mode
- Operated by integrated illuminated push button controls or remote control (optional extra)
- Activated charcoal and washable metal grease filters included
- Two 35W integrated LED lights



Stainless Steel

INTEGRATED HOOD - 900mm

- Ducted hood
- Recirculation conversion kit available (optional extra)
- Operated by illuminated push button controls
- 10 Minute delayed 'fan off'
- Dishwasher safe metal grease filters included
- Two 20W halogen lights



Stainless Steel

CO-ORDINATING COLLECTION

What looks best with your Falcon range cooker? Another Falcon, of course. Offering both traditional and contemporary styling, our range of hoods and splashbacks have been specifically designed to complement your cooker.



SEMI-PROFESSIONAL HOODS

SUPER EXTRACT HOOD

- Ducted hood
- Available in 900mm, 1000mm and 1092mm
- Three variable speed settings plus intensive (boost) mode
- Push button controls
- 10 Minute delayed 'fan off'
- Automatic switch-off if no operator action for four hours
- Grease filter cleaning alarm
- Dishwasher safe metal grease filters
- Two 2.6W integrated LED lights

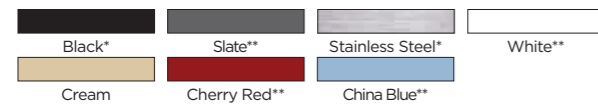

*Chrome trim **Brushed nickel trim

CONTEMPORARY HOOD

- Ducted hood
- Available in 900mm and 1090mm
- Three variable speed settings plus intensive (boost) mode
- Push button controls
- Auto fan off if no operator action for four hours
- Grease filter cleaning alarm
- Dishwasher safe metal grease filters
- Two 2.6W integrated LED lights

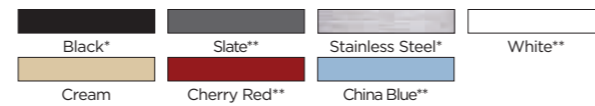

*Chrome trim **Brushed nickel trim

SUPER FLAT HOOD

- Recirculation / Ducted hood
- Available in 110cm
- Three speed settings plus intensive (boost) mode
- Electronic push button controls
- Activated charcoal and dishwasher safe metal grease filters included
- Two 20W integrated halogen lights



MERCURY PC HOOD

- Ducted hood
- Available in 1000mm, 1082mm and 1200mm
- Three speed settings plus intensive (boost) mode
- Push button controls
- Automatic switch-off if no operator action for four hours
- Grease filter cleaning alarm
- Dishwasher safe metal grease filters
- Two 2.6W integrated LED lights



MERCURY SC HOOD

- Ducted hood
- Available in 1000mm, 1082mm and 1200mm
- Three speed settings plus intensive (boost) mode
- Push button controls
- Automatic switch-off if no operator action for four hours
- Grease filter cleaning alarm
- Dishwasher safe metal grease filters
- Two 2.6W integrated LED lights



HOOD SPECIFICATIONS

CONTEMPORARY / TRADITIONAL / INTEGRATED HOODS

	Classic / Falcon				Falcon Plus				Flat				Integrated			
Speed	1	2	3		1	2	3	Boost	1	2	3	Boost	1	2	3	Boost
Air capacity m ³ /hour*	240	330	440		323	500	650	730	300	460	620	700	320	510	600	700
Air capacity m ³ /hour**	250	355	500		310	490	650	740	320	500	645	730	-	-	-	-
Pressure PA	160	210	230		375	460	490	500	330	430	490	500	330	430	470	510
Input W	70	100	145		145	180	230	250	145	180	230	250	140	175	210	275
Noise level dB(A)***	55	64	69		55	64	70	73	52	62	69	71	55	66	69	73
Energy rating	D				C				B				C			

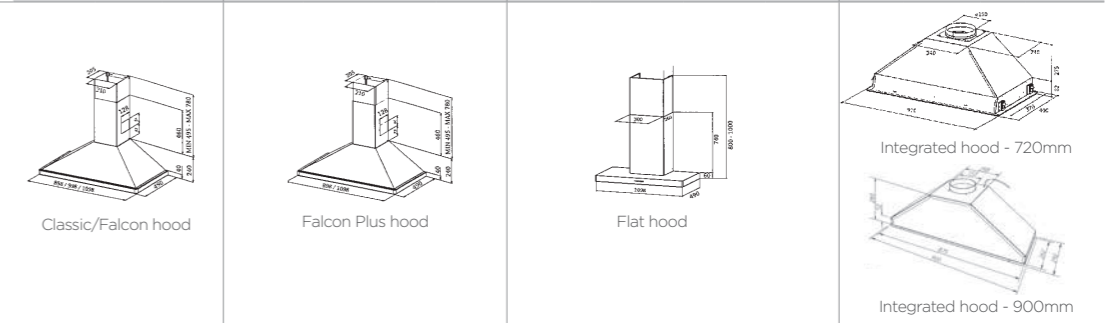

SEMI-PROFESSIONAL HOODS

	Super Extract				Contemporary				Super Flat				Mercury SC / PC			
Speed	1	2	3	4	1	2	3	4	1	2	3	Boost	1	2	3	4
Air capacity m ³ /hour*	244	480	610	685	257	403	548	773	360	550	640	740	244	378	511	775
Air capacity m ³ /hour**	-	-	-	-	-	-	-	-	370	575	680	795	-	-	-	-
Pressure PA	290	450	480	500	290	470	540	590	320	415	470	490	290	470	540	590
Input W	70	170	215	250	70	120	180	275	140	175	210	275	70	120	180	275
Noise level dB(A)***	46	62	67	70	46	53	61	69	55	65	68	72	45	53	61	70
Energy rating	A				A				D				A			

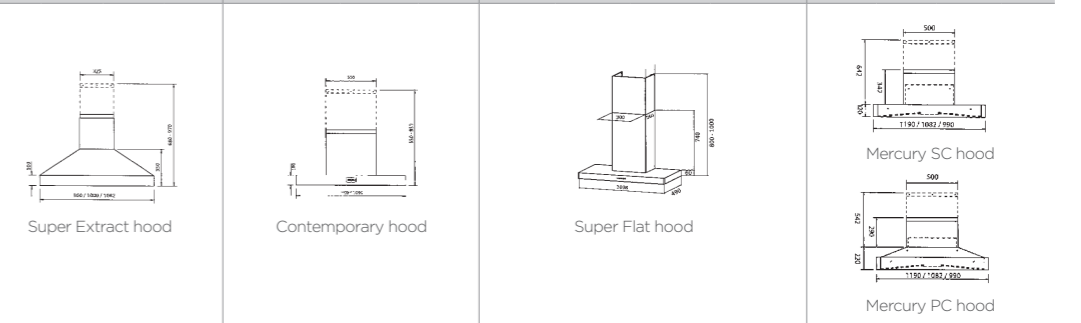

* As per IEC 61591 when cooker hood is in extraction mode ** As per IEC 61591 when there is 'free air delivery' *** EN 60704-2-13 method

SPLASHBACK COLLECTION

CLASSIC SPLASHBACK

- Available in 90cm and 110cm
- Black with brass or chrome screen printed badge
- Enamelled 1.2mm mild steel



FALCON SPLASHBACK

- Available in 90cm, 100cm and 110cm
- Enamelled 1.2mm mild steel



GLASS SPLASHBACK

- Available in 90cm, 100cm and 110cm
- Toughened glass
- Non-porous, easy to clean finish



FALCON SEMI-PROFESSIONAL / MERCURY SPLASHBACKS

- Falcon available in 900mm and 1092mm
- Mercury available in 1000mm and 1200mm
- Stainless Steel



* 90cm

SPLASHBACK SPECIFICATIONS

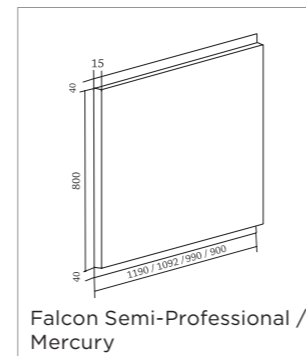
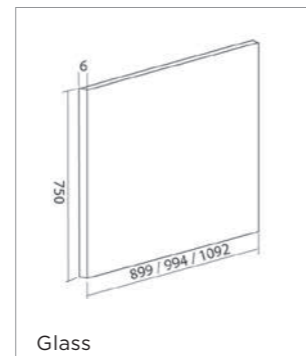
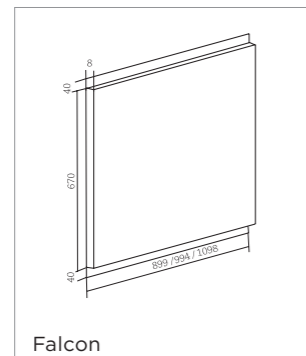
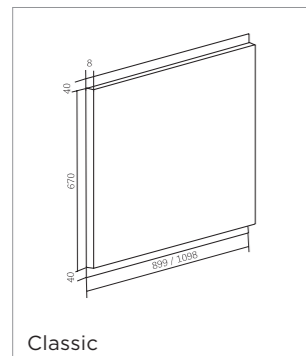

FREESTANDING REFRIGERATION

Specialists in professional-style appliances that combine form with function, Falcon presents a range of freestanding refrigeration units. As well as smart styling, the new cooling range includes a variety of high-tech features and functions to keep fresh and frozen food at its best for longer.

REFRIGERATION FEATURES AND FUNCTIONS

IONIZER



Our innovative Ionizer technology works by spreading negative ions throughout the refrigeration interior, which in turn neutralises any unpleasant odours and dust particles that could otherwise linger inside the cavity. By invisibly and silently removing them, the air quality inside the cooling appliance is instantly improved while any underlying odours are quickly eliminated.

EVEN CIRC



Keeping food fresh for longer lies at the heart of each and every Falcon refrigeration appliance; that's why we incorporate Even circ into our new collection of freestanding models. This state-of-the-art technology minimises any heat transfer from the walls inside the cooler unit to ensure that the food stored inside it stays at its optimum freshness for longer.

RANGEFRESH



Our unique Rangefresh preserving technology helps to remove ethylene gas from inside the refrigeration cavity. This gas is a harmless bio product that is released naturally from fresh foods and by eliminating it, we also remove any unwanted odours that would otherwise naturally occur. This also has the added benefit of keeping food fresh for longer.

QUICK DRINK MODE



Our innovative new refrigeration features include the Quick Drink Mode, which serves as a reminder for any drinks you place in either of the freezer compartments with the intention of cooling them quickly. Simply set the timer in five-minute increments from anywhere between five and thirty minutes and an audible alarm will sound to alert you to take the drinks out.

ECO RUNNING MODE



When you're away from home, whether for a few days or a long summer break, set the Eco Running Mode to preserve power while still keeping the food inside at its optimum temperature.

SUPER COOL MODE



Our Super Cool Mode is similar to the Super Freeze Mode, as it automatically reverts back to the last set fridge temperature after four hours unless deactivated manually. Ideal for cooling down a large quantity of fresh food after a big shop as well as swiftly chilling soft drinks and white or sparkling wine.

SUPER FREEZE MODE



Available on our American-style and French-style models, the Super Freeze Mode will automatically revert back to the last set temperature after 24 hours unless deactivated manually. It's so handy after a large food shop, when you need to freeze fresh food quickly to retain nutrients and flavour.

DOOR ALARM



It's all too easy to accidentally leave the fridge door open so make sure you never lose valuable energy and coolness with the built-in Door Alarm, which warns of any cool air escaping after just two minutes.

HOLIDAY MODE



If you're planning to be away from home for long periods, such as summer breaks or a Christmas getaway, set the Holiday Mode to keep the freezer compartment active. This way you won't be wasting valuable energy keeping the fridge running when there's nothing inside to refrigerate.

FULL WIDTH GLASS SHELVING

All our fridge compartments have full width safety glass spill-proof shelves with a stylish stainless steel trim. The shelves are also height adjustable, giving you the option to alter their position depending on the ingredients you wish to store inside. Perfect for taller bottles as well as bulky items.

EFFICIENT LED LIGHTING

LED interior lighting is energy efficient and long lasting so in our new collection of refrigeration appliances, we have centrally positioned LED lighting at the top and on the side walls within the fridge compartments. This has the advantage of giving better light dispersal within the cavity, making it easier to locate your fresh food, even those hard to find items at the back.

FROST FREE / NO FROST TECHNOLOGY

Wave goodbye to the dreaded task of defrosting the freezer. Thanks to our innovative Frost Free / No Frost Technology, there's no more chiseling away at built-up frost - a must for today's hectic lifestyles and hardworking kitchens.

INDEPENDENTLY CONTROLLED ZONES

Our American-style four-door fridge freezers come with two freezer compartments that can be independently controlled for added flexibility when it comes to storing fresh and frozen food. The bottom freezer compartments are programmed via an external control panel and can be utilised as chiller spaces instead of a freezers whenever you need it.

FRENCH-STYLE DXD



KEY FEATURES

- Impressive 557 litre net capacity
- A+ rated for energy efficiency
- Double freezer drawers including hidden basket
- Flexible shelving
- Totally frost-free
- Super Freeze and Super Cool Modes
- Holiday and Eco Modes
- Electronic 'door open' alarm
- Child Lock
- Stylish LED lighting
- External digital control display
- European sizing for streamlined fit with cabinetry



Large capacity lower freezer drawer



Rangefresh preserver



Drinks compartment

SPECIFICATIONS

Model	DXD
Energy rating	A+
Width (mm)	910
Depth (mm)	763
Height (mm)	1850
Total gross volume (litres)	653
Total net volume (litres)	557
Chiller net volume (litres)	38
Fridge net volume (litres)	390
Freezer net volume (litres)	167
Noise dB(A)	45
Rangefresh preserver	Yes
Even Circ	Yes
Ionizer	Yes
Door alarm	Yes
Frost control	No Frost
Interior LED lighting	Yes
Number of shelves - Fridge	3
Number of shelves - Freezer	0
Number of drawers - Fridge	3
Number of drawers - Freezer	2
Wine rack	No
Eco mode	Yes
Holiday mode	Yes
Quick Drink mode	Yes
Super Freeze	Yes
Super Cool	Yes
Chilled lock	Yes
Clearance - Top (mm)	150
Clearance - Back (mm)	75

AMERICAN-STYLE SXS



KEY FEATURES

- Impressive 560 litre net capacity
- A+ rated for energy efficiency
- Independently controlled freezer zones
- Four drawer and two shelf freezer compartments
- Deep fridge door shelves
- Totally frost-free
- Super Freeze and Super Cool modes
- Holiday and Eco modes
- Electronic 'door open' alarm
- Child lock
- Stylish LED lighting
- External digital control display



Freezer drawer



Even Circ



Door compartment with stainless steel trim

SPECIFICATIONS

Model	SXS
Energy rating	A+
Width (mm)	910
Depth (mm)	750
Height (mm)	1850
Total gross volume (litres)	630
Total net volume (litres)	560
Chiller net volume (litres)	38
Fridge net volume (litres)	390
Freezer net volume (litres)	170
Noise dB(A)	46
Rangefresh preserver	Yes
Even Circ	Yes
Ionizer	Yes
Door alarm	Yes
Frost control	No Frost
Interior LED lighting	Yes
Number of shelves - Fridge	3
Number of shelves - Freezer	2
Number of drawers - Fridge	3
Number of drawers - Freezer	4
Wine rack	No
Eco mode	Yes
Holiday mode	Yes
Quick Drink mode	Yes
Super Freeze	Yes
Super Cool	Yes
Chilled lock	Yes
Clearance - Top (mm)	150
Clearance - Back (mm)	75

AMERICAN-STYLE SXS DELUXE



KEY FEATURES

- Impressive 556 litre net capacity
- A+ rated for energy efficiency
- Two independently controlled freezer zones
- Four drawer and two shelf freezer compartments
- Deep fridge door shelves
- Totally frost-free
- Super Freeze and Super Cool modes
- Holiday and Eco modes
- Coolpac: removable chiller caddy for drinks
- Odour seal box: air tight box for foods with strong odours
- Vseal: Vacuum seal feature for food storage or sous-vide cooking
- Electronic 'door open' alarm
- Child lock
- Stylish LED lighting
- External digital control display



VSeal



Ionizer



Odour seal box

SPECIFICATIONS

Model	SXS DELUXE
Energy rating	A+
Width (mm)	910
Depth (mm)	750
Height (mm)	1850
Total gross volume (litres)	630
Total net volume (litres)	556
Chiller net volume (litres)	38
Fridge net volume (litres)	390
Freezer net volume (litres)	170
Noise dB(A)	45
Rangefresh preserver	Yes
Even Circ	Yes
Ionizer	Yes
Door alarm	Yes
Frost control	No Frost
Interior LED lighting	Yes
Number of shelves - Fridge	3
Number of shelves - Freezer	2
Number of drawers - Fridge	3
Number of drawers - Freezer	4
Wine rack	No
Eco mode	Yes
Holiday mode	Yes
Quick Drink mode	Yes
Super Freeze	Yes
Super Cool	Yes
Chilled lock	Yes
Clearance - Top (mm)	150
Clearance - Back (mm)	75



Distributor / Dealer Information:

Copyright © AGA Rangemaster Limited 2019
Brand names, words and logos are registered trademarks of AGA Rangemaster Limited

Falcon is a trading name of AGA Rangemaster Limited
Registered in England and Wales under registration number 3872754
Registered office: AGA Rangemaster, Meadow Lane, Long Eaton, Nottingham, NG10 2GD, United Kingdom

Falcon continuously seeks improvements in specification, design and production of products and thus, alterations take place periodically. Whilst every effort is made to produce up-to-date literature, this brochure should not be regarded as an infallible guide to current specification, nor does it constitute an offer for the sale of any particular appliance.

